

# A-10 Thunderbolt II (Warthog) SYSTEMS ENGINEERING CASE STUDY

David R. Jacques, PhD, LtCol USAF (Ret)  
Dennis D. Strouble, PhD



Photo taken by: USAF



**Air Force Center for Systems Engineering (AFIT/SY)**  
**Air Force Institute of Technology**  
**2950 Hobson Way, Wright-Patterson AFB OH 45433-7765**

## Report Documentation Page

*Form Approved*  
*OMB No. 0704-0188*

Public reporting burden for the collection of information is estimated to average 1 hour per response, including the time for reviewing instructions, searching existing data sources, gathering and maintaining the data needed, and completing and reviewing the collection of information. Send comments regarding this burden estimate or any other aspect of this collection of information, including suggestions for reducing this burden, to Washington Headquarters Services, Directorate for Information Operations and Reports, 1215 Jefferson Davis Highway, Suite 1204, Arlington VA 22202-4302. Respondents should be aware that notwithstanding any other provision of law, no person shall be subject to a penalty for failing to comply with a collection of information if it does not display a currently valid OMB control number.

1. REPORT DATE <b>2010</b>	2. REPORT TYPE	3. DATES COVERED <b>00-00-2010 to 00-00-2010</b>			
4. TITLE AND SUBTITLE <b>A-10 Thunderbolt II (Warthog) Systems Engineering Case Study</b>		5a. CONTRACT NUMBER			
		5b. GRANT NUMBER			
		5c. PROGRAM ELEMENT NUMBER			
6. AUTHOR(S)		5d. PROJECT NUMBER			
		5e. TASK NUMBER			
		5f. WORK UNIT NUMBER			
7. PERFORMING ORGANIZATION NAME(S) AND ADDRESS(ES) <b>Air Force Center for Systems Engineering (AFIT/SY), Air Force Institute of Technology, 2950 Hobson Way, Wright Patterson AFB, OH, 45433-7765</b>		8. PERFORMING ORGANIZATION REPORT NUMBER			
9. SPONSORING/MONITORING AGENCY NAME(S) AND ADDRESS(ES)		10. SPONSOR/MONITOR'S ACRONYM(S)			
		11. SPONSOR/MONITOR'S REPORT NUMBER(S)			
12. DISTRIBUTION/AVAILABILITY STATEMENT <b>Approved for public release; distribution unlimited</b>					
13. SUPPLEMENTARY NOTES					
14. ABSTRACT					
15. SUBJECT TERMS					
16. SECURITY CLASSIFICATION OF:			17. LIMITATION OF ABSTRACT	18. NUMBER OF PAGES	19a. NAME OF RESPONSIBLE PERSON
a. REPORT <b>unclassified</b>	b. ABSTRACT <b>unclassified</b>	c. THIS PAGE <b>unclassified</b>	<b>Same as Report (SAR)</b>	<b>102</b>	

## ***Foreword***

At the direction of the former Secretary of the Air Force, Dr. James G. Roche, the Air Force Institute of Technology established the Air Force Center for Systems Engineering (AF CSE) at its Wright Patterson AFB campus in 2003. With academic oversight by a subcommittee on Systems Engineering (SE), chaired by then Air Force Chief Scientist Dr. Alex Levis, the AF CSE was tasked to develop case studies of SE implementation during concept definition, acquisition, and sustainment. The committee drafted an initial case outline and learning objectives, and suggested the use of the Friedman-Sage Framework to guide overall analysis.

The Department of Defense is exponentially increasing the acquisition of joint complex systems that deliver needed capabilities demanded by our warfighter. Systems engineering is the technical and technical management process that focuses explicitly on delivering and sustaining robust, high-quality, affordable solutions. The Air Force leadership has collectively stated the need to mature a sound systems engineering process throughout the Air Force. Gaining an understanding of the past and distilling learning principles that are then shared with others through our formal education and practitioner support are critical to achieving continuous improvement.

The AF CSE has published seven case studies thus far including the; C-5A, F-111, Hubble Telescope, Theater Battle Management Core System, B-2, Joint Air-to-Surface Standoff Missile, and Global Positioning System. All case studies are available on the AF CSE website [<http://www.afit.edu/cse>]. These cases support academic instruction on SE within military service academies, civilian and military graduate schools, industry continuing education programs, and those practicing SE in the field. Each of the case studies is comprised of elements of success as well as examples of SE decisions that, in hindsight, were not optimal. Both types of examples are useful for learning. Plans exist for future case studies on the Peacekeeper ICBM and NASA's International Space Station.

Along with discovering historical facts we have conducted key interviews with program managers and chief engineers, both within the government and those working for the various prime and subcontractors. From this information we have concluded that the discipline needed to implement SE and the political and acquisition environment surrounding programs continue to challenge our ability to provide balanced technical solutions. We look forward to your comments on this A-10 "Warthog" case study and our other AF CSE published studies.

GEORGE E. MOONEY, SES  
Director, Air Force Center for Systems Engineering  
Air Force Institute of Technology

**The views expressed in this Case Study are those of the author(s) and do not reflect the official policy or position of the United States Air Force, the Department of Defense, or the United States Government**

# TABLE OF CONTENTS

<b>FOREWORD</b> .....	<b>ii</b>
<b>1 SYSTEMS ENGINEERING PRINCIPLES</b> .....	<b>1</b>
1.1 GENERAL SYSTEMS ENGINEERING PROCESS .....	1
1.2 DOD DIRECTIVE 5000 DOCUMENTS .....	3
1.3 EVOLVING SYSTEMS ENGINEERING PROCESS .....	4
1.4 CASE STUDIES .....	4
1.5 FRAMEWORK FOR ANALYSIS .....	6
<b>2 A-10 SYSTEM DESCRIPTION</b> .....	<b>8</b>
2.1 CHARACTERISTICS .....	8
2.2 OPERATIONAL DEPLOYMENTS .....	12
<b>3 THE A-10 STORY</b> .....	<b>13</b>
3.1 ORIGINS OF THE REQUIREMENTS FOR A CLOSE AIR SUPPORT AIRCRAFT .....	13
3.1.1 <i>Early Doctrinal Considerations</i> .....	13
3.1.2 <i>Lessons from Vietnam</i> .....	13
3.1.3 <i>Army Helicopter Developments and the “Johnson-McConnell Agreement”</i> .....	14
3.2 CONCEPT FORMULATION .....	16
3.2.1 <i>The Tactical Force Structure</i> .....	16
3.2.2 <i>Initiation of Concept Formulation</i> .....	17
3.2.3 <i>Early Concept Studies</i> .....	17
3.2.4 <i>The Concept Formulation Package</i> .....	22
3.2.5 <i>Contract Definition</i> .....	28
3.3 PROGRAM FORMULATION .....	32
3.3.1 <i>Request for Proposals</i> .....	32
3.3.2 <i>Program Initiation for the CAS Gun System</i> .....	33
3.4 PARALLEL UNDOCUMENTED DEVELOPMENT – THE COMPETITIVE PROTOTYPES .....	36
3.4.1 <i>Program Office Activities</i> .....	36
3.4.2 <i>The Prototypes</i> .....	36
3.4.3 <i>Competitive Fly-offs and Shoot-offs</i> .....	38
3.5 FULL SCALE DEVELOPMENT .....	41
3.5.1 <i>Program Management</i> .....	41
3.5.2 <i>The A-10/A-7D Fly-off</i> .....	41
3.5.3 <i>GAU-8/A Compatibility Testing</i> .....	43
3.5.4 <i>The Armor Piercing Round</i> .....	44
3.6 PRODUCTION AND DEPLOYMENT .....	45
3.6.1 <i>Production Readiness Issues</i> .....	45
3.6.2 <i>Hails Report and Recommendations</i> .....	46
3.6.3 <i>DSARC Reviews and Production Decisions</i> .....	48
3.6.4 <i>Variant Considerations and Production End</i> .....	49
3.7 RETIREMENT PLANS, OPERATIONS, SUSTAINMENT ... AND LIFE EXTENSION .....	50
3.7.1 <i>The Continuing Debate over the CAS Aircraft</i> .....	50
3.7.2 <i>Desert Storm and Post War Assessments</i> .....	52
3.7.3 <i>Structural Integrity Issues and HOG UP</i> .....	54
3.7.4 <i>A Second Life for a Modern Day Hog</i> .....	60

<b>4</b>	<b>SUMMARY .....</b>	<b>62</b>
<b>5</b>	<b>REFERENCES .....</b>	<b>64</b>
<b>APPENDIX A:</b>	<b>FRIEDMAN-SAGE MATRIX WITH A-10 LEARNING PRINCIPLES .....</b>	<b>A-1</b>
<b>APPENDIX B:</b>	<b>AUTHOR BIOGRAPHIES .....</b>	<b>B-2</b>
<b>APPENDIX C:</b>	<b>TACTICAL AIR CONTROL SYSTEM – CIRCA 1968 .....</b>	<b>C-1</b>
<b>APPENDIX D:</b>	<b>CONCEPT FORMULATION TRADE SPACE ANALYSIS.....</b>	<b>D-1</b>
	<b>COMBAT RADIUS AND LOITER TIME CONSIDERATIONS .....</b>	<b>D-1</b>
	<b>SURVIVABILITY.....</b>	<b>D-3</b>
	<b>WEATHER SUITABILITY .....</b>	<b>D-7</b>
	<b>COMPARISON OF CANDIDATE AIRCRAFT CHARACTERISTICS AND COST EFFECTIVENESS.....</b>	<b>D-8</b>
<b>APPENDIX E:</b>	<b>CONCEPT FORMULATION – CANDIDATE CONFIGURATIONS.....</b>	<b>E-1</b>
<b>APPENDIX F:</b>	<b>PROPOSED A-X CONFIGURATIONS .....</b>	<b>F-1</b>
<b>APPENDIX G:</b>	<b>AIR FORCE FACT SHEET.....</b>	<b>G-1</b>

## LIST OF FIGURES

Figure 1. The Systems Engineering Process as Presented by DAU .....	2
Figure 2. "Hogs" in Flight.....	7
Figure 3. External View Drawings of the A-10 Aircraft .....	8
Figure 4. A-10 Inboard Profile.....	8
Figure 5. The Teeth of the Hog.....	12
Figure 6. Vietnam era CAS Aircraft: The A-1E Skyraider (L) and A-37A Dragonfly (R).....	14
Figure 7. Army's AH-56 Cheyenne.....	15
Figure 8. Early Competitors for the CAS Mission - The F-5 (L) and the A-7D (R) .....	17
Figure 9. Coordination for Pre-Planned CAS Requests.....	23
Figure 10. Close Air Support Mission Sequence.....	24
Figure 11. Sortie Rates for Aircraft in SEA.....	25
Figure 12. The GAU-8/A Gun System .....	35
Figure 13. The YA-9A Prototype .....	37
Figure 14. The YA-10A Prototype .....	38
Figure 15. YA-9A Flight Test.....	38
Figure 16. The YA-10A on Landing.....	39
Figure 17. Pre-production and Prototype A-10s .....	43
Figure 18. A-10A Firing the GAU-8/A .....	45
Figure 19. A-10 Fuselage and Wing Production .....	47
Figure 20. Flight Testing the YA-10B.....	50
Figure 21. One of the Six A-10s Lost in Desert Storm.....	53
Figure 22. Repaired Aircraft 80-186.....	54
Figure 23. FSMP Establishes Required Maintenance Actions .....	57
Figure 24. WS 23 - DTA versus ACI Findings .....	57
Figure 25. Comparison of 1999 and 2003 HOG UP Program.....	59
Figure 26. A Newly Modified A-10C.....	61
Figure C-2. The Tactical Air Control System (circa 1968) .....	C-1
Figure D-1. Radius Req'd for 90-Percent Geo-Area Coverage from Available Runways.....	D-1
Figure D-2. Response Time Versus Mission Radii and Cruise Speed .....	D-1
Figure D-3. Impact of Loiter Time and Sortie Rate on Force Requirements .....	D-2
Figure D-4. Maintenance Man-Hours per Flying Hour for USAF Fighters .....	D-2
Figure D-5. Anti-Aircraft Weapons (Field Forces) .....	D-3
Figure D-6. Ground Fire Attrition in South Vietnam and Laos.....	D-4
Figure D-7. Cause of Aircraft Ground Fire Loss in Southeast Asia.....	D-5
Figure D-8. Relative Aircraft Attrition Versus Velocity and Maneuver .....	D-5
Figure D-9. Time and Space Required for Re-Attack Minimum time Trajectory.....	D-6
Figure D-10. Availability of Weather Suitable for CAS Operations.....	D-7
Figure D-11. Attack Profile Nomogram .....	D-7
Figure D-12. Useful Load Versus Takeoff Ground Roll Distance .....	D-8
Figure D-13. Useful Load Versus Landing Ground Roll Distance .....	D-8
Figure D-14. Payload Versus Loiter Time.....	D-9
Figure D-15. Ordnance Payload Versus Loiter Time .....	D-9
Figure D-16. Candidate Comparison Ordnance Capacity .....	D-10

## LIST OF TABLES

Table 1. A Framework of Key Systems Engineering Concepts and Responsibilities .....	6
Table 2. Key A-10 Milestones and Events .....	9
Table 3. A-10 Characteristics .....	11
Table 4. A-X Requirements from Dec 1966 Requirements Action Directive .....	18
Table 5. A-X Avionics Packages .....	21
Table 6. Availability of Weather Suitable for CAS Operations .....	26
Table 7. Candidate CAS Aircraft Characteristics .....	28
Table 8. Changes in the Representative A-X Associated with DCP-23A .....	31
Table 9. A-X Proposal Summary .....	33
Table 10. Performance Comparison of the GAU-8/A and GAU-9/A .....	40
Table 11. A-10 Structural Configurations .....	55

# 1 Systems Engineering Principles

## 1.1 General Systems Engineering Process

The Department of Defense continues to develop and acquire joint systems and to deliver needed capabilities to the warfighter. With a constant objective to improve and mature the acquisition process, it continues to pursue new and creative methodologies to purchase these technically complex systems. A sound systems engineering process, focused explicitly on delivering and sustaining robust, high-quality, affordable products that meet the needs of customers and stake holders must continue to evolve and mature. Systems engineering is the technical and technical management process that results in delivered products and systems that exhibit the best balance of cost and performance. The process must operate effectively with desired mission-level capabilities, establish system-level requirements, allocate these down to the lowest level of the design, and ensure validation and verification of performance, meeting cost and schedule constraints. The systems engineering process changes as the program progresses from one phase to the next, as do the tools and procedures. The process also changes over the decades, maturing, expanding, growing, and evolving from the base established during the conduct of past programs. Systems engineering has a long history. Examples can be found demonstrating a systemic application of effective engineering and engineering management, as well as poorly applied, but well defined processes. Throughout the many decades during which systems engineering has emerged as a discipline, many practices, processes, heuristics, and tools have been developed, documented, and applied.

Several core lifecycle stages have surfaced as consistently and continually challenging during any system program development. First, system development must proceed from a well-developed set of requirements. Secondly, regardless of the evolutionary acquisition approach, the system requirements must flow down to all subsystems and lower level components. And third, the system requirements need to be stable, balanced and must properly reflect all activities in all intended environments. However, system requirements are not unchangeable. As the system design proceeds, if a requirement or set of requirements is proving excessively expensive to satisfy, the process must rebalance schedule, cost, and performance by changing or modifying the requirements or set of requirements.

Systems engineering includes making key system and design trades early in the process to establish the system architecture. These architectural artifacts can depict any new system, legacy system, modifications thereto, introduction of new technologies, and overall system-level behavior and performance. Modeling and simulation are generally employed to organize and assess architectural alternatives at this introductory stage. System and subsystem design follows the functional architecture. System architectures are modified if the elements are too risky, expensive or time-consuming. Both newer object-oriented analysis and design and classic structured analysis using functional decomposition and information flows/data modeling occurs. Design proceeds logically using key design reviews, tradeoff analysis, and prototyping to reduce any high-risk technology areas.

Important to the efficient decomposition and creation of the functional and physical architectural designs are the management of interfaces and integration of subsystems. This is



applied to subsystems within a system, or across large, complex systems of systems. Once a solution is planned, analyzed, designed, and constructed, validation and verification take place to ensure satisfaction of requirements. Definition of test criteria, measures of effectiveness (MOEs), and measures of performance (MOPs), established as part of the requirements process, takes place well before any component/subsystem assembly design and construction occurs.

There are several excellent representations of the systems engineering process presented in the literature. These depictions present the current state of the art in the maturity and evolution of the systems engineering process. One can find systems engineering process definitions, guides, and handbooks from the International Council on Systems Engineering (INCOSE), Electronic Industries Association (EIA), Institute of Electrical and Electronics Engineers (IEEE), and various Department of Defense (DoD) agencies and organizations. They show the process as it should be applied by today’s experienced practitioner. One of these processes, long used by the Defense Acquisition University (DAU), is depicted by Figure 1. It should be noted that this model is not accomplished in a single pass. This iterative and nested process gets repeated to the lowest level of definition of the design and its interfaces. Formal models such as these did not appear until after the A-10 program had finished production, but many of the processes were already in practice with both the government and contractor workforces during the time of A-10 development.

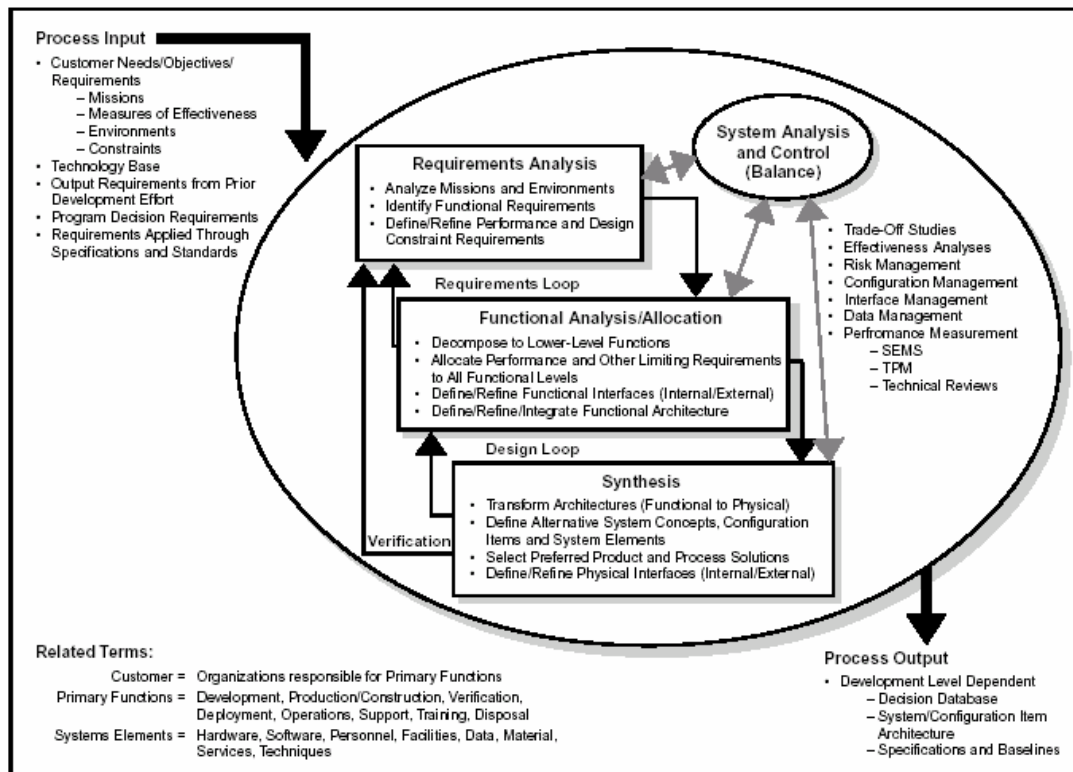

**Figure 1. The Systems Engineering Process as Presented by DAU**

## 1.2 DoD Directive 5000 documents

During President Richard Nixon's first term, Secretary of Defense Melvin Laird faced congressional attempts to lower defense spending. The cause was Vietnam and the rising cost of defense acquisition, as well as emerging energy and environmental programs. Laird and David Packard, his deputy, recognized the need for a mechanism to control and manage spending especially with the coming fiscal constraint. In May 1969 Packard formed the Defense Systems Acquisition Review Council (DSARC) to advise on the acquisition of major weapon systems. It was chartered to review major milestones as well as conduct occasional management reviews. One year later in 1970<sup>i</sup>, Packard issued a policy memorandum that was to become the foundation for the DoD 5000 series of documents<sup>ii</sup> which were first issued in 1971, and as of January 2008 have been reissued 10 times. The original purpose of DoD 5000 was to improve the management of acquisition programs and included policy to streamline management, decentralize execution and use appropriate management structures.<sup>1</sup> The 1971 issue of DoD 5000 established the following program considerations (abbreviated here) pertaining to progression of a program through the acquisition process.<sup>2</sup>

1. System need shall be clearly established in operational terms, with appropriate limits, and shall be challenged throughout the acquisition process...Wherever feasible, operational needs shall be satisfied through the use of existing military or commercial hardware...
2. Cost parameters shall be established which consider the cost of acquisition and ownership... Practical tradeoffs shall be made between system capability, cost and schedule...
3. Logistic support shall also be considered as a principle design parameter...
4. Programs shall be structured and resources allocated to assure that the demonstration of actual achievement is the pacing function... Schedules and funding profiles shall be structured to accommodate unforeseen problems and permit task accomplishment without unnecessary overlapping or concurrency.
5. Technical uncertainty shall be continually assessed... Models, mock-ups and system hardware will be used to the greatest possible extent to increase confidence level.
6. Test and evaluation shall commence as early as possible. A determination of operational suitability, including logistics support requirements, will be made prior to large scale production commitments...
7. Contract type shall be consistent with all program characteristics, including risk...
8. The source selection decision shall take into account the contractor's capability to develop a necessary defense system on a timely and cost-effective basis...
9. Management information/program control requirements shall provide information which is essential to effective management control... Documentation shall be generated in the minimum amount to satisfy necessary and specific management needs.

---

<sup>i</sup> 1970 was also the year that the competitive prototype program for the A-X was approved; the program which eventually produced the A-10.

<sup>ii</sup> DoD Directive 5000.1, and its accompanying DoD Instruction 5000.2.

The publication of DoD 5000 did not occur until a few months after the start of the A-10 development program, but these policy ideas from the Office of the Secretary of Defense clearly influenced the A-10 program formulation. In some respects, the A-10 program was a test bed for considerations such as design-to-cost, supportability in design, and competitive prototyping. While there have been variations and additions to these program considerations over the years since the first issuance of DoD 5000, the policy has retained many of the principles laid out in these requirements.

### **1.3 Evolving Systems Engineering Process**

The DAU model, like all others, has been documented in the last two decades, and has expanded and developed to reflect a changing environment. Systems are becoming increasingly complex internally and more interconnected externally. The process used to develop the aircraft and systems of the past was a process effective at the time. It served the needs of the practitioners and resulted in many successful systems in our inventory. Notwithstanding, the cost and schedule performance of the past programs are fraught with examples of some well-managed programs and ones with less stellar execution. As the nation entered the 1980s and 1990s, large DoD and commercial acquisitions were overrunning costs and behind schedule. Aerospace industry primes were becoming larger and more geographically and culturally distributed, and they worked diligently to establish common systems engineering practices across their enterprises. However, these common practices must be understood and be useful both within the enterprise and across multiple corporations and vendor companies because of the mega-trend of teaming in large (and some small) programs. It is essential that the systems engineering process effect integration, balance, allocation, and verification and be useful to the entire program team down to the design and interface level.

Today, many factors overshadow new acquisition; including system-of-systems (SoS) context, network centric warfare and operations, an increased attention to human systems integration, and the rapid growth in information technology. These factors are driving a more sophisticated systems engineering process with more complex and capable features, along with new tools and procedures. One area of increased focus of the systems engineering process is the informational systems architectural definitions used during system analysis. This process, described in the DoD Architectural Framework (DoDAF)<sup>5</sup>, emphasizes greater reliance on reusable architectural views describing the system context and concept of operations, interoperability, information and data flows and network service-oriented characteristics.

### **1.4 Case Studies**

The systems engineering process to be used in today's complex system and system-of-systems projects is a process matured and founded on principles developed in the past. Examination of systems engineering principles used on programs, both past and present, can provide a wealth of lessons to be used in applying and understanding today's process. It was this thinking that led to the initiation of the Air Force Center for Systems Engineering case study effort, as well as the present continuation of that effort.

The purpose of developing detailed case studies is to support the teaching of systems engineering principles. They will facilitate learning by emphasizing to the student the long-term

consequences of the systems engineering and programmatic decisions on program success. The systems engineering case studies will assist in discussion of both successful and unsuccessful methodologies, processes, principles, tools, and decision material to assess the outcome of alternatives at the program/system level. In addition, the importance of using skills from multiple professions and engineering disciplines and collecting, assessing, and integrating varied functional data will be emphasized. When they are taken together, the student is provided real-world, detailed examples of how the process attempts to balance cost, schedule and performance.

The utilization and mis-utilization of systems engineering principles will be highlighted, with special emphasis on the conditions that foster and impede good systems engineering practice. Case studies should be used to illustrate both good and bad examples of acquisition management and learning principles, to include whether:

- every system provides a satisfactory balanced and effective product to a customer;
- effective requirements analysis was applied;
- consistent and rigorous application of systems engineering management standards was applied;
- effective test planning was accomplished;
- there were effective major technical program reviews;
- continuous risk assessments and management was implemented;
- there were reliable cost estimates and policies;
- they used disciplined application of configuration management;
- a well defined system boundary was defined;
- they used disciplined methodologies for complex systems ;
- human systems integration was accomplished
- problem solving incorporated understanding of the system within the larger operational environment

The systems engineering process transforms an operational need into a system or system-of-systems. Architectural elements of the system are allocated and translated into detailed design requirements. The systems engineering process, from the identification of the need to the development and utilization of the product, must continuously integrate and balance the requirements, cost, and schedule to provide an operationally effective system throughout its life cycle. Systems engineering case studies highlight the various interfaces and communications to achieve this balance, which include:

- The program manager/systems engineering interface between the operational user and developer (acquirer) essential to translate the needs into the performance requirements for the system and subsystems.
- The government/contractor interface essential for the practice of systems engineering to translate and allocate the performance requirements into detailed requirements.
- The developer (acquirer)/user interface within the project, essential for the systems engineering practice of integration and balance.

The systems engineering process must manage risk, both known and unknown, as well as both internal and external. This objective will specifically capture those external factors and the impact of these uncontrollable influences, such as actions of Congress, changes in funding, new

instructions/policies, changing stakeholders or user requirements or contractor and government staffing levels.

## 1.5 Framework for Analysis

The Air Force Center for Systems Engineering case studies will present learning principles specific to each program, but will utilize the Friedman-Sage framework<sup>4</sup> to organize the assessment of the application of the systems engineering process. The systems engineering case studies published by AFIT employed the Friedman-Sage construct and matrix as the baseline assessment tool to evaluate the conduct of the systems engineering process for the topic program.

The framework and the derived matrix can play an important role in developing case studies in systems engineering and systems management, especially case studies that involve systems acquisition. The Friedman-Sage framework is a nine row by three column matrix shown in Table 1.

**Table 1. A Framework of Key Systems Engineering Concepts and Responsibilities**

Concept Domain	Responsibility Domain		
	1. Contractor Responsibility	2. Shared Responsibility	3. Government Responsibility
A. Requirements Definition and Management			
B. Systems Architecting and Conceptual Design			
C. System and Subsystem Detailed Design and Implementation			
D. Systems and Interface Integration			
E. Validation and Verification			
F. Deployment and Post Deployment			
G. Life Cycle Support			
H. Risk Assessment and Management			
I. System and Program Management			

Six of the nine concept domain areas in Table 1 represent phases in the systems engineering lifecycle:

- A. Requirements Definition and Management
- B. Systems Architecting and Conceptual Design
- C. Detailed System and Subsystem Design and Implementation
- D. Systems and Interface Integration
- E. Validation and Verification
- F. System Deployment and Post Deployment.

Three of the nine concept areas represent necessary process and systems management support:

- G. Life Cycle Support
- H. Risk management
- I. System and Program Management.

While other concepts could have been identified, the Friedman–Sage framework suggests these nine are the most relevant to systems engineering in that they cover the essential life cycle processes in systems acquisition and the systems management support in the conduct of the process. Most other concept areas that were identified during the development of the matrix appear to be subsets of one of these. The three columns of this two-dimensional framework represent the responsibilities and perspectives of government and contractor, and the shared responsibilities between the government and the contractor. In teaching systems engineering in DoD, there has previously been little distinction between duties and responsibilities of the government and industry activities. While the government has responsibility in all 9 concept domains, its primary objective is establishing mission requirements.



**Figure 2. "Hogs" in Flight**

## 2 A-10 System Description

### 2.1 Characteristics

The A-10A Thunderbolt II, manufactured by Fairchild Republic Corp. between 1975 and 1984, was specifically designed as a Close Air Support (CAS) aircraft. It was named after another aircraft manufactured by Republic Aircraft, the P-47 Thunderbolt of WW II fame, but is commonly referred to by its nickname, “Warthog”, due to its unusual appearance (Figures 3,4). The A-10, which has survived several attempts of program cancellation and early retirement, is now projected to operate until 2028, well beyond its original requirement. The A-10 has several configurations including the original A-10A, the A-10B, a two-seat version designed for all-weather/night attack and pilot training (only one was produced), the OA-10A, used for forward air controller (FAC) missions, and the recent A-10C, an upgraded version of the A-10A. A timeline of key events associated with the A-10 appears in Table 2.

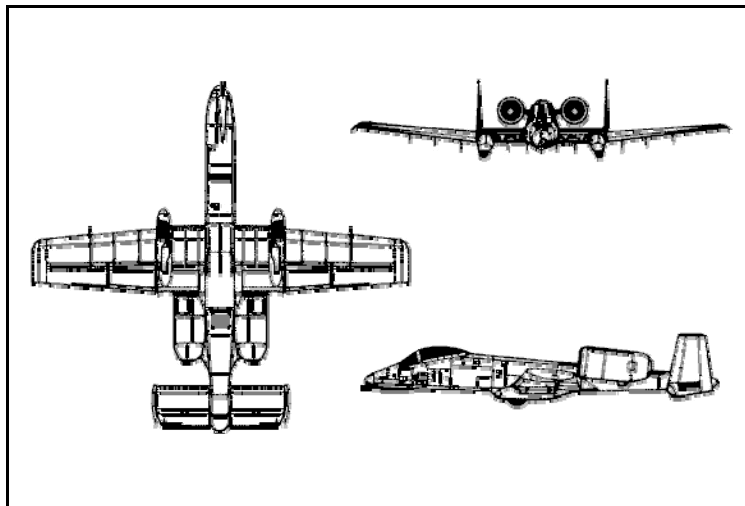

Figure 3. External View Drawings of the A-10 Aircraft

#### A-10 INBOARD PROFILE

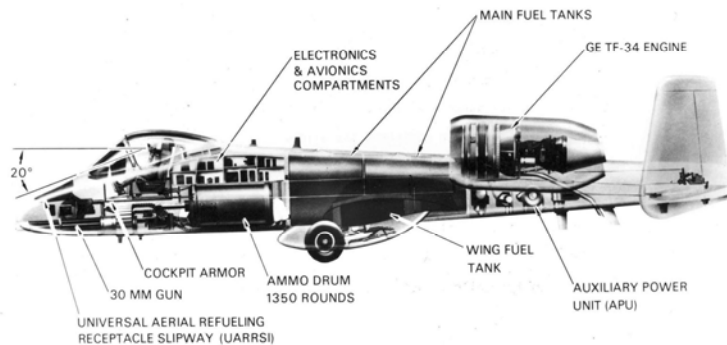

Figure 4. A-10 Inboard Profile

**Table 2. Key A-10 Milestones and Events**

<b>Year</b>	<b>Milestone/Event</b>
7 Jun 1961	Secretary of Defense Robert McNamara directs that two new tactical aircraft, one of which is for CAS, should be developed
7 Jan 1965	The Secretary of Defense asks the Air Force to look at the requirements for a CAS aircraft for both the near-term and for long-term follow-on development
Dec 1965	Secretary of Defense McNamara authorizes the Air Force to acquire the A-7D, a modification of the Navy's A-7, for the interim CAS role
22 Dec 1966	HQ USAF issues a Requirements Action Directive (RAD) for a specialized CAS aircraft labeled the A-X that will satisfy long-term CAS objectives
6 Mar 1967	A request for information (RFI) is sent to industry for A-X system studies
19 Apr 1967	AFRDQ (Deputy for Studies and Analysis, Systems Engineering Group) completes the A-X Proposal
1 Sep 1967	Industry completes its system studies
1 Mar 1968	HQ USAF completes the initial Concept Formulation Package (CFP) for the A-X
11 Dec 1968	A Development Concept Paper (DCP 23) is drafted for the A-X program
6 Jun 1969	A Technical Development Plan (TDP) is developed for the A-X program by AFSC/ASD
Sep 1969	The Air Force recommends development of an internally-mounted 30 mm Gatling gun system (with associated rounds) as an integral component of the A-X aircraft
6 Apr 1970	Deputy Secretary of Defense David Packard approves DCP 23A and its competitive prototype approach (termed "Parallel Undocumented Development")
27 Apr 1970	The A-X System Program Office is established at Wright-Patterson AFB
8 May 1970	A Request for Proposal (RFP) is released to 12 companies for the A-X
7 Aug 1970	Six companies respond to the A-X RFP (Boeing, Cessna, Northrop, Fairchild Republic, General Dynamics and Lockheed)
16 Nov 1970	The Air Force releases an RFP for the GAU-8/A 30-mm cannon to industry
18 Dec 1970	Northrop (YA-9A) and Fairchild Republic (YA-10A) are chosen to build competitive prototypes for the A-X program
Jun 1971	General Electric and Philco-Ford are awarded contracts for the competitive development of the GAU-8/A gun system and practice ammunition
10 May 1972	First flight of the YA-10A occurs (competitive flight evaluation begins)
20 May 1972	First flight of the YA-9A occurs (competitive flight evaluation begins)
10 Oct – 9 Dec 1972	The flyoff between the YA-9A and the YA-10A occurs
17 Jan 1973	The Air Force selects the YA-10A as the winner of the competition
21 Jun 1973	General Electric is awarded the development contract for the GAU-8/A gun system



Jul 1973	The Senate Armed Services Committee cuts A-10 funding and recommends a flyoff between the YA-10A and the A-7D
25 Mar 1974	Flight testing is completed for the A-10 prototype with the GAU-8/A gun installed
15 Apr - 9 May 1974	The flyoff between the YA-10A and A-7D occurs (the YA-10A is declared the winner)
11 Sep 1974	Testing is completed for the AGM-65A Maverick air-to-ground missile with the A-10 aircraft
31 Oct 1974	Qualification tests of the TF34-GE-100 engine is completed
15 Feb 1975	A-10 development test & evaluation testing begins at Edwards AFB
13 Jun 1975	Initial Operational Test & Evaluation Phase II flight testing is completed
21 Oct 1975	The first production A-10 flies at the Fairchild Republic plant in Farmingdale, NY
28 Oct 1975	Testing of the reinforced cracked fuselage frame is completed and the 6,000-hour mark is attained
13 Nov 1975	The A-10 successfully demonstrates the lethality of the GAU-8/A against tank targets at Nellis AFB
10 Feb 1976	The Air Force authorizes Fairchild Republic to begin full production of the A-10 at a rate of 15 aircraft per month
Oct 1977	The first A-10 squadron goes operational
Mar 1984	A-10 production ends at 713 aircraft (including 6 pre-production)
Oct 1987	USAF starts converting some A-10s to forward air control aircraft, OA-10s
1988	USAF considers replacing the A-10 with an F-16 variant, the A-16
1990	The A-10 is modified to incorporate the Low Altitude Safety and Targeting Enhancements (LASTE) system
17 Jan – 27 Feb 1991	Operation Desert Storm (Iraq-Kuwait)
3 Mar – 6 Jun 1999	Operation Allied Force (Kosovo)
1999	The A-10 begins upgrade with the installation of an Embedded Global Positioning System/Inertial Navigation System (EGI), HOG UP program begins with intent of extending structural life to 2028
7 Oct 2001	War in Afghanistan begins
18 Feb 2003	Red Team issues report on HOG UP program – major problems noted
20 Mar 2003	Operation Iraqi Freedom begins
Jun 2004	HOG UP wing fails fatigue test catastrophically – triggers business case analysis for manufacture of replacement wings
2005	Upgrading to A-10C begins (improved fire control, electronic countermeasures, precision guided munitions carriage)
2007	Boeing awarded contract to manufacture replacement wings
2009	Projected engine upgrade
2028	A-10's projected retirement

The primary roles of the A-10/OA-10 include close air support, forward air controller, combat search and rescue, special operations, and interdiction. A-10/OA-10 Thunderbolt IIs have excellent maneuverability at low air speeds and altitude, and are highly accurate weapons-delivery platforms. They can loiter near battle areas for extended periods of time and operate under 1,000-foot ceilings (303.3 meters) with 1.5-mile (2.4 kilometers) visibility. Their wide combat radius and short takeoff and landing capability permit operations in and out of locations near front lines. A single seat cockpit forward of the wings, and a large bubble canopy provide pilots with all-around vision. Later modifications of the A-10/OA-10 added Night Vision Imaging Systems. The pilots are protected by titanium armor that also protects parts of the flight-control system. The redundant primary structural sections allow the aircraft to enjoy better survivability during close air support than did previous aircraft. The aircraft can survive direct hits from armor-piercing and high explosive projectiles up to 23mm. Their self-sealing fuel cells are protected by internal and external foam. Manual systems back up their redundant hydraulic flight-control systems. This permits pilots to fly and land when hydraulic power is lost. The Thunderbolt II can be serviced and operated from bases with limited facilities near battle areas. Many of the aircraft's parts are interchangeable left and right, including the engines, main landing gear and vertical stabilizers. Table 3 shows some of the characteristics of the A-10.

**Table 3. A-10 Characteristics<sup>5</sup>**

	<b>General Characteristics</b>
Primary Function	A-10 – Close air support OA-10 – Airborne forward air control
Crew	One pilot
Contractor	Fairchild Republic Co.
Date Deployed	March 1976
Length	53 ft, 4 in
Height	14 ft, 8 in
Wingspan	57 ft, 6 in
	<b>Performance</b>
Power Plant	Two General Electric TF34-GE-100 turbofans
Thrust	9,065 lbs each engine
Speed	420 mph (Mach 0.56)
Ceiling	45,000 ft
Range	800 mi
Maximum Takeoff Weight	51,000 lbs
	<b>Armament</b>
	One GAU-8/A seven-barrel Gatling gun
	Up to 16,000 lbs of mixed ordnance, AGM-65 Maverick missiles, and laser-guided guided bombs
	Infrared and electronic countermeasures
	2.75 in rockets
	Illumination flares
	AIM-9 Sidewinder missiles

## 2.2 Operational Deployments

In March 1976, the 355<sup>th</sup> Tactical Training Wing at Davis-Monthan Air Force Base was the first unit to get the A-10 Thunderbolt II. Initial overseas deployments included England, Japan, and Germany. The A-10 was deployed in combat for the first time during the Gulf War in 1991. It proved to be a very reliable and effective aircraft. They flew over eight thousand sorties, while losing only six planes. Even though the battle damage assessment was conservatively estimated, A-10s were credited with “destroying 987 tanks, 926 artillery pieces, 501 armored personnel carriers, and 1,106 trucks. Hogs also destroyed other targets, such as Scud missile sites, Surface to Air Missile (SAM) sites, and two helicopters.”<sup>6</sup> The aircraft has participated with outstanding results in most combat operations since then, including Allied Force (Kosovo), Enduring Freedom (Afghanistan) and Iraqi Freedom.



Figure 5. The Teeth of the Hog

## **3 The A-10 Story**

### **3.1 Origins of the Requirements for a Close Air Support Aircraft**

#### **3.1.1 Early Doctrinal Considerations**

The A-10 was somewhat forced on a reluctant Air Force by the needs of the Army. Prior history and experiences in World War II by both the Allied and Axis powers had helped shape the doctrine of the Air Force to emphasize strategic bombing and air superiority over CAS. Even in the area of ground attack, Battlefield Air Interdiction was considered much more decisive, and therefore more important, than CAS. The Air Force believed that fighters that were not otherwise engaged could take on CAS when needed. The Air Force emphasized airplanes with speed for survivability. The service believed that a pilot trained to perform air-to-air could easily perform the air-to-ground mission and thus provided flexibility and a better use of resources. Additionally, the Air Force believed that a dedicated attack plane would be limited in capabilities and vulnerable. The Air Force had abandoned its attack designator, “A”, for its aircraft, and the clear trend was for larger, faster multi-role fighter aircraft (“F” designated). The Army, on the other hand, needed an aircraft that could carry a great amount of ordnance, loiter in the area for some time with excellent maneuverability, and had the ability to take hits from enemy ground fire. There was also a concern over control of assets. When the Army needed support, its needs were immediate.<sup>7,8</sup> By the early 1960s, the Army was evolving around new tactics of air mobility, and it wanted close air support that could adapt to these new tactics.

#### **3.1.2 Lessons from Vietnam**

With regards to CAS and the ability to conduct counterinsurgency, the Air Force was largely unprepared for the Vietnam War. Its main line fighter, the F-105, was big and fast, but “the ability to fly closely and slowly enough to see the target, to work safely in poor weather, to carry sufficient ordnance, and to remain over the battle area were all limited.”<sup>9</sup> The Air Force F-4C<sup>iii</sup> would not arrive in Vietnam until December 1964 and, although it carried a heavier bomb load than the F-105, it still did not have the low speed, low altitude and loiter capability needed in a CAS aircraft. The Air Force initially had to rely on ex-trainers and WWII-vintage attack planes such as the T-28D and the B-26. These were short-lived solutions, however, as the slow speed and lack of armor on the T-28D made it vulnerable to ground fire, and the aging B-26’s were eventually grounded due to structural problems. A better interim solution became available with the use of the semi-obsolete Navy A-1 Skyraider<sup>10</sup> (see Figure 6). The A-1 had good low-speed maneuverability, it could carry upwards of 8,000 lbs of bombs, and it was able to loiter around the battlefield and respond quickly to calls for support fires. “Even many of those who favored the supersonic jets conceded that the propeller-driven A-1 was the CAS star.”<sup>11</sup> Limitations of the A-1 were the limited number of them available from the Navy (production had ended in 1957) and its inability to destroy more heavily armored targets. Losses of the A-1 continued to escalate in the mid 1960s; particularly due to the radar guided Anti-Aircraft

---

<sup>iii</sup> The F-4C was an adaptation of a Navy aircraft designed as a fleet defense fighter. While the Air Force may have been reluctant to adopt a Navy aircraft, they soon valued it as a fighter bomber and would eventually procure more F-4’s than the Navy. The F-4 saw service with the Air Force from 1964 until 1996, and droned versions of the aircraft are still in use today.

Artillery (AAA) guns being employed by North Vietnam. The A-37A<sup>iv</sup> (Figure 6), an adaptation of the T-37<sup>v</sup> subsonic trainer, was developed as a counterinsurgency aircraft and deployed to Vietnam in 1967, but the A-37A had neither the payload capacity nor the loiter time of the A-1E.

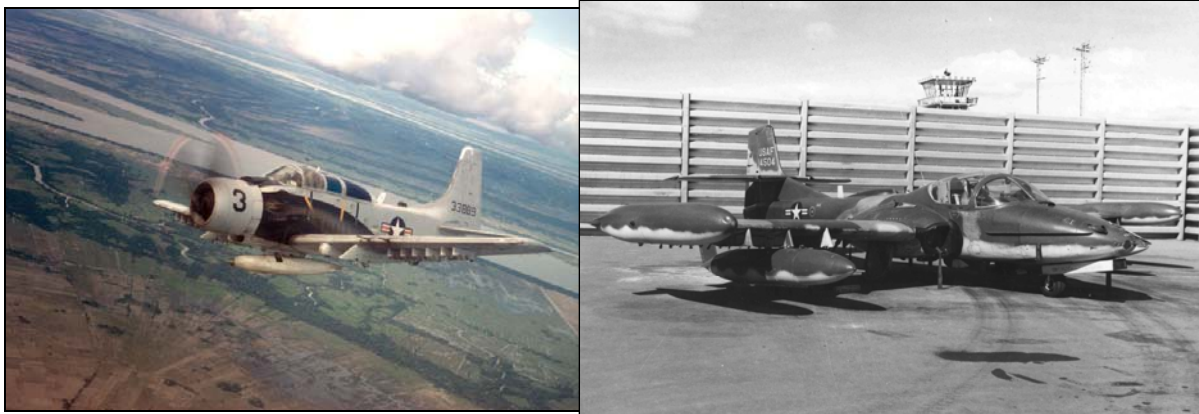

**Figure 6. Vietnam era CAS Aircraft: The A-1E Skyraider (L) and A-37A Dragonfly (R)**

### 3.1.3 Army Helicopter Developments and the “Johnson-McConnell Agreement”

In Vietnam the Army was trying out its new air mobile tactics, and they began employing armed helicopters to provide close air support to friendly ground forces. The Army also wanted to expand the use of its Caribou light transport aircraft for resupply in forward areas, but attempts to expand their fleet of Caribou and Mohawk fixed wing observation aircraft in FY65 were rejected by Secretary of Defense Robert McNamara. Congress was starting to pay attention to the growing debate over CAS, and the Air Force was receiving most of the blame for the problems. Existing doctrine concerning the roles and missions assigned to each service permitted the Army to have “armed helicopters, which may direct ‘suppressive fire’ at the enemy, but [it], may not have fixed-wing aircraft to provide ‘close air support’ for its ground troops. A helicopter can *supplement* close air support, but existing limitations preclude it from delivering sufficient sustained firepower to *provide* close air support”<sup>12</sup> The Army’s transition into a role normally provided by the Air Force, namely close air support, created tension between the services.

During the early stages of the Vietnam War, the Army began development of an attack helicopter for use in providing air cover for ground forces. The Advanced Aerial Fire Support System (AAFSS), or AH-56A Cheyenne, was designed as a large, fixed-wing and rotary-wing aircraft with sophisticated avionics and a greatly increased capacity for attacking ground targets (see Figure 7). The AH-56A had a maximum speed of 214 knots and was armed with a 30-mm automatic gun in the belly turret and a 40-mm grenade launcher (or 7.62 mm Gatling gun) in the chin turret. It also carried TOW anti-tank missiles and 2.75 in. rocket launchers.<sup>13</sup> The Air

<sup>iv</sup> An improved variant of the A-37, the A-37B, began production in 1967. These were primarily intended for the South Vietnamese Air Force as replacements for their aging A-1’s.

<sup>v</sup> In the 1950s the Air Force had loaned three Cessna T-37As to the Army to conduct tests of CAS in project “Long Arm”. Although the aircraft did not have any armament, they were capable of being fitted with a cannon and racks for bombs and rockets. The trial proved successful and the Army Aviation Board recommended a large procurement. The Air Force moved to stop the idea and the aircraft were returned and no further action was taken.

Force perceived the Cheyenne's primary function as providing fire support, so it believed the Cheyenne should compete with other aircraft having a similar function. The Cheyenne would continue to complicate the early formulation and development of the Air Force CAS aircraft.



**Figure 7. Army's AH-56 Cheyenne**

By early 1966, the Air Force was facing growing pressure to step up in a big way to support CAS. US Representative Otis Pike chaired a subcommittee that convened for seven days in fall of 1965, and the subcommittee released its report in February 1966.<sup>14</sup> The report was very critical of the Air Force for not having developed, nor pursuing development of, an aircraft suitable for the CAS mission. It was in this political environment that, in early spring of 1966, Army Chief of Staff General Harold Johnson and Air Force Chief of Staff General John McConnell “met secretly to resolve air support differences that the Vietnam War had aggravated.”<sup>15</sup> The Army was committed to helicopter fire support, but Vietnam showed good airlift support from Air Force aircraft, and the Army was denied recently by Secretary of Defense McNamara when it attempted to expand their support aircraft numbers. The Air Force wanted the Army out of the airborne fire support business, but likely did not have the political support to do that given the criticism it was receiving regarding the CAS mission. The Johnson-McConnell agreement shifted the prevailing responsibility criteria of aircraft weight to one of aircraft type. Under this agreement, the Air Force retained the CAS mission but recognized the role of Army helicopters to provide fire support. For its part, the Army agreed to give up its large fixed-wing transports to the Air Force. This agreement resolved some issues regarding service responsibilities, and it provided the framework by which the two services pursued aircraft system development for the ensuing decades. The agreement did not, however, resolve the roles and missions questions surrounding CAS, and Air Force CAS developments continued to compete with Army helicopter developments throughout the late 1960s and 1970s.

## 3.2 Concept Formulation

### 3.2.1 The Tactical Force Structure

In March of 1965, the Air Staff completed a study laying out the desired tactical force structure. It recommended a mix of aircraft to include the F-4<sup>vi</sup>, F-111<sup>vii</sup> and other less expensive aircraft yet to be named. In particular, the Air Force recognized the need for a lower cost tactical fighter that was optimized for close support, but would possess general capabilities in ground attack, special air warfare operations, and would have the capability to survive air-to-air defenses as well as ground defenses.<sup>16</sup> The aircraft being considered for this acquisition were the A-7, in current production by the Navy, and the F-5, which was primarily being produced under the Military Assistance Program in support of America's NATO<sup>viii</sup> and SEATO<sup>ix</sup> allies (see Figure 8). While neither of these aircraft could be optimized for the close support role, their other attributes fit with the desire of the Air Force to pursue multi-role aircraft. Regardless of which aircraft was chosen, the Air Force position was that either represented only an interim measure until a more suitable low-cost tactical fighter could be identified or developed.

The Air Force's choice for the interim low-cost tactical fighter was initially an improved variant of the F-5 because it had better air-to-air capability than the A-7. Then Secretary of the Air Force Eugene Zuckert communicated that decision to the Secretary of Defense. In April 1965 the Director of Defense Research and Engineering (DDR&E) accepted the Air Force choice and subsequently authorized the Air Force to pursue development of a follow-on lower cost multipurpose fighter, the F-X<sup>x</sup>. Despite their early preference for the F-5, a joint study on the cost effectiveness of alternative aircraft conducted in the summer and fall of 1965 by the Air Force and the Office of the Secretary of Defense (OSD) resulted in a revised recommendation by the Air Force to pursue acquisition of the A-7D, a new variant of the existing Navy A-7 aircraft. The A-7D was expected to be low cost (about \$1.5M/aircraft) and quickly obtainable, and the OSD authorized the Air Force to begin acquisition in December 1965. The Air Force awarded a contract to procure the A-7D in October 1966. Tactical Air Command subsequently pushed for changes to the A-7, and a joint study group between the Navy and the Air Force recommended an improved system including new engines and avionics. This set the A-7D program back by 2-3 years, and by 1971 the cost had grown to about \$3.4M, resulting in greatly reduced numbers of A-7D's produced for the Air Force.

---

<sup>vi</sup> The F-4 was being produced as an Air Force variant beginning in 1963. Although it was evaluated for close air support, its primary missions would be interdiction and counter-air operations.

<sup>vii</sup> The Tactical Fighter Experimental (TFX) program began in 1961, and would later be designated the F-111. It was intended to fulfill a Navy fleet defense interceptor requirement as well as an Air Force supersonic strike aircraft requirement. The Air Force F-111A first flew in 1964, but would not enter operational service until 1967. The Navy F-111B was canceled before it entered production.

<sup>viii</sup> NATO – North Atlantic Treaty Organization

<sup>ix</sup> SEATO – South-East Asia Treaty Organization

<sup>x</sup> The Fighter Experimental (F-X) program evolved into the F-15 program, but the early concept development for the A-X program was done by a cadre of engineers within the F-X program office.

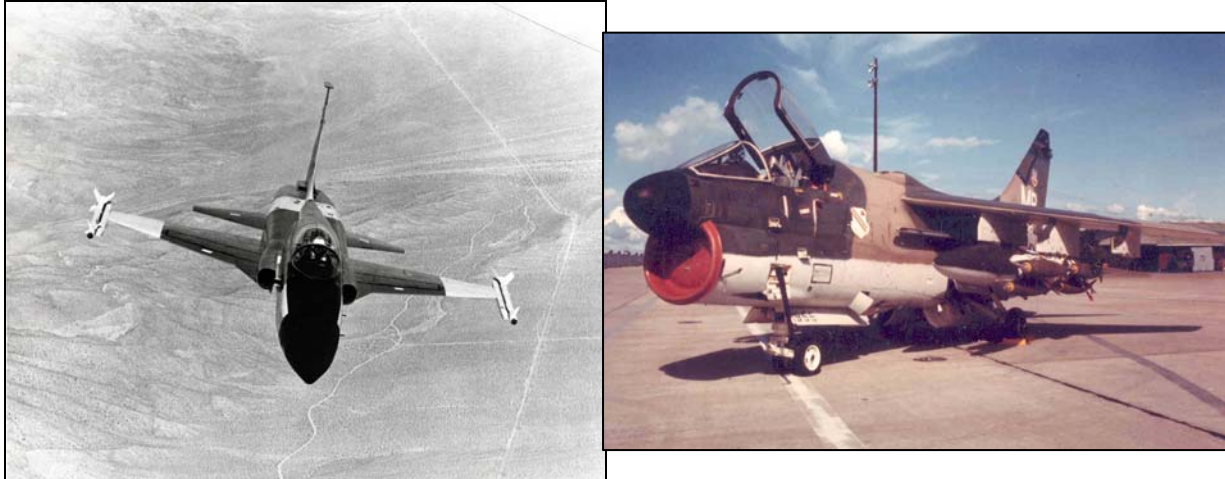

**Figure 8. Early Competitors for the CAS Mission - The F-5 (L) and the A-7D (R)**

### **3.2.2 Initiation of Concept Formulation**

The growing use of armed helicopters in Vietnam continued to raise concerns within the Air Force. In June 1966 Air Force Chief of Staff General John McConnell directed that a study be done to determine what aspects of CAS were not being performed to the satisfaction of the Army, and what should be done to acquire equipment to meet the deficiencies. While the study, completed in August 1966, concluded that the Army was generally satisfied with Air Force supplied CAS, it also revealed that the Army was withholding some categories of CAS for fulfillment by Army helicopters. Further, it found that the Air Force aircraft lacked the capabilities to perform the helicopter escort and suppressive fire roles.<sup>17</sup> The Army was bridging these gaps by arming helicopters, and increasing expenditures for the UH-1H Cobra helicopter gunship and the development effort on the Army Advanced Aerial Fire Support System (AAFSS) caused further concern to the Air Force.

The CAS study provided two important recommendations for the Air Force: “(1) the Air Force should take steps to highlight in official USAF doctrine, tactics and procedures publications the methods for accomplishing those missions for which the armed helicopters were provided and which the Air Force considered part of the close air support function; and (2) to fulfill the requirements for the 1970 plus time period, the Air Force should take immediate and positive steps to obtain a specialized close air support aircraft, simpler and cheaper than the A-7, and with equal or better characteristics than the A-1.”<sup>18</sup> On 8 September 1966, General McConnell directed that the Air Force take immediate action to design, develop, and obtain a specialized close air support aircraft, and on 22 December 1966, Headquarters USAF issued a Requirements Action Directive (RAD) for a specialized aircraft designated the A-X<sup>19</sup>.

### **3.2.3 Early Concept Studies**

The RAD for the A-X directed Air Force Systems Command (AFSC) to prepare a Concept Formulation Package (CFP) and a preliminary Technical Development Plan (TDP). It cited an urgent need (IOC<sup>xi</sup> of 1970) which dictated maximum employment of existing state-of-

<sup>xi</sup> Initial Operational Capability (IOC) for the A-X was interpreted as the delivery of the first 18 aircraft to operational inventory.



the-art technology in its design, thus allowing for a compressed conceptual design phase. The A-X would be designed to provide close air support of ground units, escort of helicopters and low performance aircraft, protection of landing surface forces and vehicle convoys, and armed reconnaissance.

The A-X was to be a single-man, lightweight aircraft with sufficient range and capacity to carry a maximum payload at low altitude from a Main Operating Base (MOB) to a forward area with a significant loiter time on station. Maneuverability requirements stressed agility in attack and reattack maneuvering at low speed, and the A-X required stability throughout a weapon release speed range of 200-400 knots<sup>xii</sup>. Key requirements are shown in Table 4 below.

**Table 4. A-X Requirements from Dec 1966 Requirements Action Directive**

Performance Parameter	Desired	Required
Gross Weight (lbs)	22,500	30,000
Payload - Mixed Ordnance (lbs)	8,000	6,000
Combat Radius (nautical miles)	---	200
Loiter Time @ Combat Radius (hrs)	---	2
Min Maneuvering Speed @ 5000 ft (knots)	120	150
Turn Radius @ Combat Weight (ft)	1,000	2,000
Max Speed @ Sea Level w/ Ext. Ordnance (knots)	550	450

The A-X RAD called for fixed, internally mounted guns with a “capability equal to or better than four M-39 20mm guns”<sup>20</sup>. It also added consideration for a large caliber semiautomatic recoilless rifle. A minimum of six ordnance stations were required capable of delivering all types of conventional ordnance projected for use through 1970-1985. Although the intended operating scenarios stressed a permissive environment, the CFP was to consider the feasibility of incorporating a limited air-to-air missile capability as a defensive measure. Survivability from ground fire was an essential characteristic for the A-X. Structural and system design would need to provide inherent survivability, to include self sealing fuel tanks and, if power flight controls were used, a manual backup system would be provided. The pilot and critical flight systems would be protected from 14.5mm projectiles (common Soviet Anti-Aircraft shells). The aircraft was to “incorporate maintainability characteristics which will make it possible for this system to meet its combat operational objectives with a minimum of maintenance effort and expenditure.”<sup>21</sup>

The A-X was to use an existing state-of-the-art engine in order to achieve an early Initial Operational Capability (IOC). The number and type of engines was not specified by the RAD; they would be determined by trade-space analysis considering performance, cost, survivability and maintainability. The A-X would also use existing state-of-the-art equipment for avionics (communications, navigation, and weapons delivery systems). Communication equipment was to be compatible with Forward Air Control (FAC) equipment and Army airborne vehicles. Navigation equipment was to be capable of night and adverse weather navigation from the MOB

<sup>xii</sup> knots – Nautical Miles (NM) per hour

to the target, and would also allow maximum range ferry flight and Continental US (CONUS) operation using conventional radio-navigation facilities. The weapon delivery system required a depressable-reticle fixed optical sight. A slant-ranging device with an automatic release system was desirable if it could be obtained within the cost, availability, reliability and accuracy constraints. Based on Air Force and contractor studies, the estimated unit flyaway cost for the A-X was \$1 - \$1.2M (FY70\$) depending on purchase quantities. Research and Development costs were estimated at \$240M.

The F-X System Program Office (SPO) within the Aeronautical Systems Division (ASD) of AFSC was assigned supervision of the A-X concept formulation and program planning. Beginning in January 1967, ASD began preparation of government configuration studies, and a Request for Proposal (RFP) to industry for system studies. The RFP was released in March 1967, and on 1 May 1967 four contracts were awarded to McDonnell Douglas, Northrop, Grumman, and General Dynamics. The contractor studies were to be complete by 1 September 1967, and were to include point designs, supporting data, and detailed development plans. The contractor studies were to be used, along with the ASD configuration studies, for the Concept Formulation Package.

On 19 April 1967, the F-X SPO forwarded a preliminary proposal<sup>22</sup> to AFSC headquarters. The AFRDQ A-X Proposal contained the Air Force (ASD) configuration studies for two candidate vehicles. The first vehicle configuration used a single turbo-prop engine, while the second vehicle configuration used two wing-mounted turbofan engines. Neither of these configurations was considered optimal, but they were considered representative of aircraft available in the 1970 time period. Each design was “a single place vehicle incorporating the baseline avionics complement and a single 30mm modified M-61 gun with 1000 rounds of ammunition.”<sup>23</sup> The proposal contained not only the configuration data, but probability of survivable and vulnerable areas, performance assessments, and cost and schedule estimates. Data on optimum weapons and delivery conditions for the A-X was provided by the Air Force Armament Laboratory. The design mission for the proposal consisted of: 5 minute warm-up and take-off; climb to 5000 ft at optimum power setting; cruise to 200 NM at 250 knots; loiter for 2 hours at 5000 ft; descent to sea level for 15 minutes of combat at 250-300 knots; climb to 5000 ft at optimum power setting; cruise back to base at 5000 ft, 250 knots; descent and landing with reserve fuel for 20 minutes loiter at sea level. Weapon loading for the design mission included seven MK117 general purpose bombs at 830 lbs each, and 1000 rounds of ammunition.

The vehicle design analysis investigated the parameters of wing loading (W/S) and aspect ratio and their relation to the major design requirements. The gross weights to accomplish the design mission were calculated for fixed values of aspect ratio and wing loading. The results indicated that “for a given wing loading, lower aspect ratios, in spite of greater induced drag during the mission, result in smaller vehicles. This is directly the result of lower wing weights based on the design factor.”<sup>24</sup> Other performance requirements considered included low speed maneuverability, cruise speed, take-off distance, and ferry range with and without external fuel tanks. The analysis led to a selected design point which could meet or exceed all requirements.

The turboprop design was based on the GE T64-16 turboshaft engine. The engine was being developed for the Army's AAFSS Cheyenne helicopter, and full qualification tests for the

engine were scheduled for March 1968. This engine was capable of approximately 10,000 lbs thrust at sea level, and resulted in an aircraft gross weight of 27,700 lbs. For the turboprop design, the minimum gross weight (27,700 lbs) for the aircraft was determined by the sustained 1.5 g turn requirement and “for an arbitrary upper aspect ratio of 7”<sup>25</sup>. A design point with an aspect ratio of 7 and wing loading of 60 met or exceeded all requirements for the turboprop design. The turbofan design was based on the GE CF700-2c engine because “it was the only turbofan type available in the thrust class of interest for a twin engine configuration.”<sup>26</sup> The sea level maximum thrust for this engine was 3,880 lbs resulting in an aircraft gross weight of 28,800 lbs. Only limited data was provided for the turbofan design due to the poor performance predicted for that configuration. Specifically, poor fuel flow characteristics and inadequate thrust available from the turbofan engines resulted in aircraft performance not meeting requirements for loiter time, take-off distance, and low speed maneuverability.

The contributions from the Air Force Armament Laboratory included two options for an internal gun on the A-X. Option I was a modification of the proven M-61 20 mm gun rebarreled to fire the Army WECOM 30 mm round. It had a lower muzzle velocity (2200 ft/sec), but accommodated a larger round with lower recoil. A six barrel configuration provided a rate-of-fire up to 6000 rounds/minute. Importantly, the modified M-61 gun was considered achievable within the schedule of the A-X. Option II consisted of a 25 mm gun with higher muzzle velocity (4000 ft/sec) providing longer stand-off and a secondary air-to-air capability. However, it had a higher recoil and the delivery date for a fully qualified gun system was estimated to be 1972 (outside the schedule of the A-X, which had a target IOC of 1970). On 5 January 1968 the Air Staff issued a Requirements Action Directive for Air-to-Ground Gun Systems for Close Support Aircraft<sup>27</sup>. This RAD instructed AFSC to plan the development and acquisition of an air-to-ground gun system including associated rounds as an integral component of the A-X. The directive specified three target types for the new gun: troops in foliage in foxholes; tanks and armored personnel carriers; and hard targets such as bunkers and revetted guns. The RAD specified required probability of kill ( $P_k$ ) for each of these target types. At the time the services had in development or production several air-to-ground missile systems with good effectiveness against these same target types, but each system had limitations in application.<sup>28</sup> The guidance systems of these missiles required good visibility and greater distance, and the wider collateral damage limited their use in situations when friendly troops were engaging the enemy at close range.

The avionics for the A-X were specified in terms of a “skeleton” package (below minimum requirements), a “lean” package (met only minimum requirements) and three add-on packages that would supplement the “lean” package.<sup>29</sup> Table 5, reproduced from an AFSC Historical Publication, lists the A-X avionics equipment packages as well as their projected weights and costs. The “skeleton” avionics package included only communication and Visual Flight Rules (VFR) navigation aids. The “lean” package added Doppler Navigation for night and adverse weather, and a radar ranger and gun camera for improved weapons accuracy and post-attack effectiveness evaluation. The “lean” package met requirements for three of the four indicated missions, but was considered inadequate for armed reconnaissance in the immediate battlefield area. The first add-on option improved capabilities for finding targets and terrain avoidance – considered important when hunting for targets. The second add-on improved capabilities for locating vehicles by adding moving target indication (MTI) to the radar and

inertial supplements to the Doppler navigation system to improve the over-all accuracy. The third add-on package provided increased strike capability with the addition of the Maverick missile.<sup>xiii</sup> According to the A-X Proposal, “the prime mission of the A-X and the Maverick are the same – air-to-surface close support, the Maverick should be one of the prime weapons of the A-X.”<sup>30</sup> Incorporation of the Maverick missile required a cockpit television display for aligning the missile’s seeker on the target. All equipment was considered to be existing state-of-the-art technology achievable within the development timelines for the A-X.

**Table 5. A-X Avionics Packages<sup>31</sup>**

A-X AVIONICS EQUIPMENT					
"SKELETON" Below Minimum	"Lean" Minimum	"Lean" Plus 1st Add-On	"Lean" Plus 2d Add-On	"Lean" Plus 3d Add-On	
VHF/FM (With Homer)	Doppler Navigator	Radar Added Functions	MTI to Radar	Maverick	
UHF/AM (ADF)	Radar Ranger	Terrain Avoidance	Inertial Nav.		
IFF (A-G)	VHF/FM (With Homer)	(Manual)	Night Sight		
Voice Scrambler	UHF/AM (ADF)	PPI Map	(Optical)		
Intercom	IFF (A-G)	Beacon Interrogation			
TACAN	Voice Scrambler				
UHF/ADF	Intercom				
Radio Altimeter	TACAN				
ILS	UHF/ADF				
Air Data Converter (Computer)	Radio Altimeter				
Attitude, Heading, Reference	ILS				
S-Band Radar Beacon	Air Data Converter (computer				
Continuous-Solution Stabilized Sight	Attitude, Heading, Reference				
(Depressable Optical Sight)	Continuous-Solution Stabilized				
Gun Camera (2) Maurer 220	Sight (Depressable Optical Sight)				
Integrated Armament Control System	Gun Camera (2) Maurer 220				
	Integrated Armament Control System				
<b>COSTS</b>	\$127,780	\$34,000	\$10,000	\$20,000	\$16,000
Accumulative Costs		161,780	171,780	191,780	207,780
Weight (Pounds)	367	83	20	35	40
Accumulative Weight	367	450	470	505	545

The required IOC of December 1970 was considered high risk with respect to cost and schedule, but achievable if the concept definition phase was reduced to a four month contract definition phase followed by a competitive source selection of design proposals, with subsequent award of a single development contract that would include go-ahead for production of the total system. The compressed schedule would not allow any prototype evaluation phase that was favored by some leaders in the Air Force.<sup>32</sup> The proposed program would require concurrent development among wind tunnel test, engineering design, design and fabrication of tooling, and manufacture of the aircraft. It also required a shortened flight test program, with overlapping Category I, II and III testing.<sup>xiv</sup> Given the potential for cost and schedule problems associated with this approach, “a more realistic schedule would be one in which the IOC date is delayed at

<sup>xiii</sup> The AGM-65 “Maverick” missile was in early development at the time of A-X Concept Formulation. The rocket propelled, TV-guided AGM-65A reached IOC in 1972, and later variants of the missile are still in use by the Air Force as of the publication date of this case study. The principal targets for the AGM-65 are relatively small, hard targets (e.g., main battle tanks).

<sup>xiv</sup> Category I, II and III flight testing referred to developmental test, initial operational test, and operational testing, respectively. Air Force regulations at the time specified that Category I and II testing would be complete prior to Category III flight tests.

least 12 months.”<sup>33</sup> Assuming a largely successful program, the projected unit cost (FY70\$) for the turboprop version was \$0.837M (600 aircraft buy) - \$0.937M (400 aircraft buy). The projected unit cost for the turbofan version was \$0.989M (600 aircraft buy) - \$1.092M (400 aircraft buy).

### 3.2.4 The Concept Formulation Package

Using the government AFRDQ A-X Proposal and the four contractor studies, the A-X working group prepared a Concept Formulation Package (CFP). The purpose of the package was “to justify conditional approval for Contract Definition and Engineering/Operational Systems Development for a new specialized Close Air Support Aircraft (A-X).”<sup>34</sup> The initial CFP, delivered on 1 March 1968, was revised by the Air Staff in May 1968. The revised plan provided a six month slip in the IOC date.

The CFP defined the close air support mission as having three tasks: Close Support Fire (CSF), Armed Escort (AE), and Armed Reconnaissance (AR). The first two were considered complementary and the most important of the three tasks. AR involved different weapons and target acquisition systems, and other systems with AR capabilities such as the AC-130<sup>xv</sup> gunship were already under development. Further, the A-X designed for CSF/AE would have inherent capabilities for day and night visual AR. Studies of weather in South-East Asia, Europe, and Korea showed only 5-14% weather restricted hours for a maneuverable CAS aircraft capable of operating with a 1000 ft cloud ceiling and visibility of 1 mile (the minimums required). Future avionics developments were expected to improve significantly the night and non-visual weapons delivery, and a specialized AR version of the A-X was considered an attractive growth option.

The CFP identified four key characteristics for the CAS mission: responsiveness, lethality, survivability, and simplicity. Counter to some proponents within the Air Force, responsiveness was not determined by speed, but from the ability to operate from forward area basing and extensive loiter time in the battlefield area. Responsiveness also dictated that it be able to interface with Air Force and Army Command, Control and Communication (C<sup>3</sup>) equipment. Lethality would be determined by a varied payload of bombs, rockets, guided missiles and a “new large-caliber high velocity, high-rate-of-fire gun.”<sup>35</sup> Survivability would require protection from small arms, 7.62 mm and 14.5 mm machine guns, anti-aircraft artillery (principally the Soviet ZSU-23 mm system), REDEYE and other Surface-to-Air (SAM) missiles. Survivability would depend on maneuverability, redundancy and shielding of critical subsystems (and the pilot), small aircraft size, shielding of IR<sup>xvi</sup> sources, and weapon delivery systems that would reduce the amount of time the aircraft was vulnerable and allow for greater flexibility in approach and delivery of weapons. Finally, it was intended that simplicity of design would lead to a shorter development time, lower life cycle cost, reduced maintenance times, increased sortie rates, and the ability to operate from austere bases.

---

<sup>xv</sup> In 1967, the Air Force modified a C-130A transport aircraft into an AC-130A “Spectre” gunship. The AC-130A utilized side mounted Gatling guns and an analog fire control computer to provide close support fires. Successful tests of the prototype led to an immediate deployment to South Vietnam in Sept 1967, and subsequent production of additional aircraft. While the AC-47 gunship preceded the AC-130 by about two years, it was not widely used for armed reconnaissance. The AC-47 was also considered to be underpowered and vulnerable to ground fire.

<sup>xvi</sup> Infrared (IR) sources, particularly the engine exhaust, made the aircraft vulnerable to detection by air defense systems, and were targetable by increasingly proliferated IR guided SAM’s.

Extensive analysis was done on how the CAS mission would originate and be conducted. Figure 9 shows the Army/Air Force communication and the required interfaces for the pre-planned CAS mission requests. It assumed target acquisition would be made by Army units and coordinated through the Army/Air Force net. To support immediate requests, the Direct Air Support Center would request a number of alert aircraft for the following day from the Tactical Air Control Center. "Forward basing and co-location of CAS aircraft with Army units allows shortening of the request process and substantial reduction of response time."<sup>36</sup> Further, it was intended that the forward based aircraft would be in direct communication with the Forward Air Controller (FAC) and Tactical Air Control Party (TACP) attached to the ground forces, thus allowing employment in the same manner as alert aircraft. Figure 10 depicts the CAS mission sequence for both pre-planned and immediate request missions. For the CSF and AE tasks, the target area or route and general target type is known. For the AR task, the reconnaissance area is known but the type and number of targets is unknown. A description of how the A-X would interface with the Tactical Air Control System appears as Appendix C.

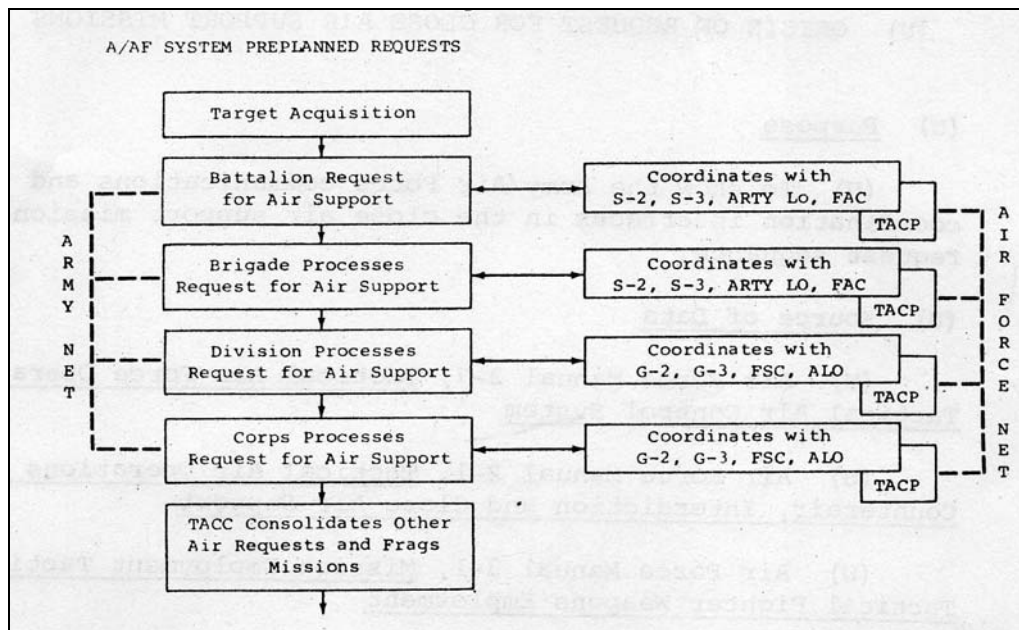

**Figure 9. Coordination for Pre-Planned CAS Requests<sup>37</sup>**

The CFP contained extensive trade studies to translate the four key characteristics into aircraft performance requirements. Some of these trade studies are shown in Appendix D. Responsiveness was translated into requirements for combat radius, minimum take-off distance (driven by the need to operate out of forward bases with short runways), cruise speed and loiter time. Loiter time and sortie rate were used to determine the size of the force required (including amount of ordnance) to maintain continuous alert over the battle area. Maintenance man-hours per flying hours (MMH/FH) emerged as a key metric and direct indicator of aircraft complexity and was plotted against peak and sustained sortie rates for a range of aircraft operating in South-East Asia (see Figure 11). Of note, there was an observed ratio of more than 3:1 in MMH/FH between the most complex and the simplest strike aircraft, with the F-4 and F-105 aircraft having actual MMH/FH values of 33.2 and 27.6, respectively, and A-1 and A-37 having values of 14.3 and 7.8, respectively.<sup>38</sup> Sustained sortie rate was determined to be relatively insensitive to

aircraft complexity, most likely due to lower than maximum sortie rates. Together with the higher allowable peak sortie rates, the most valuable aspect of simplicity was shown to be the ability to operate from austere forward bases, with the attendant improvement in response time.

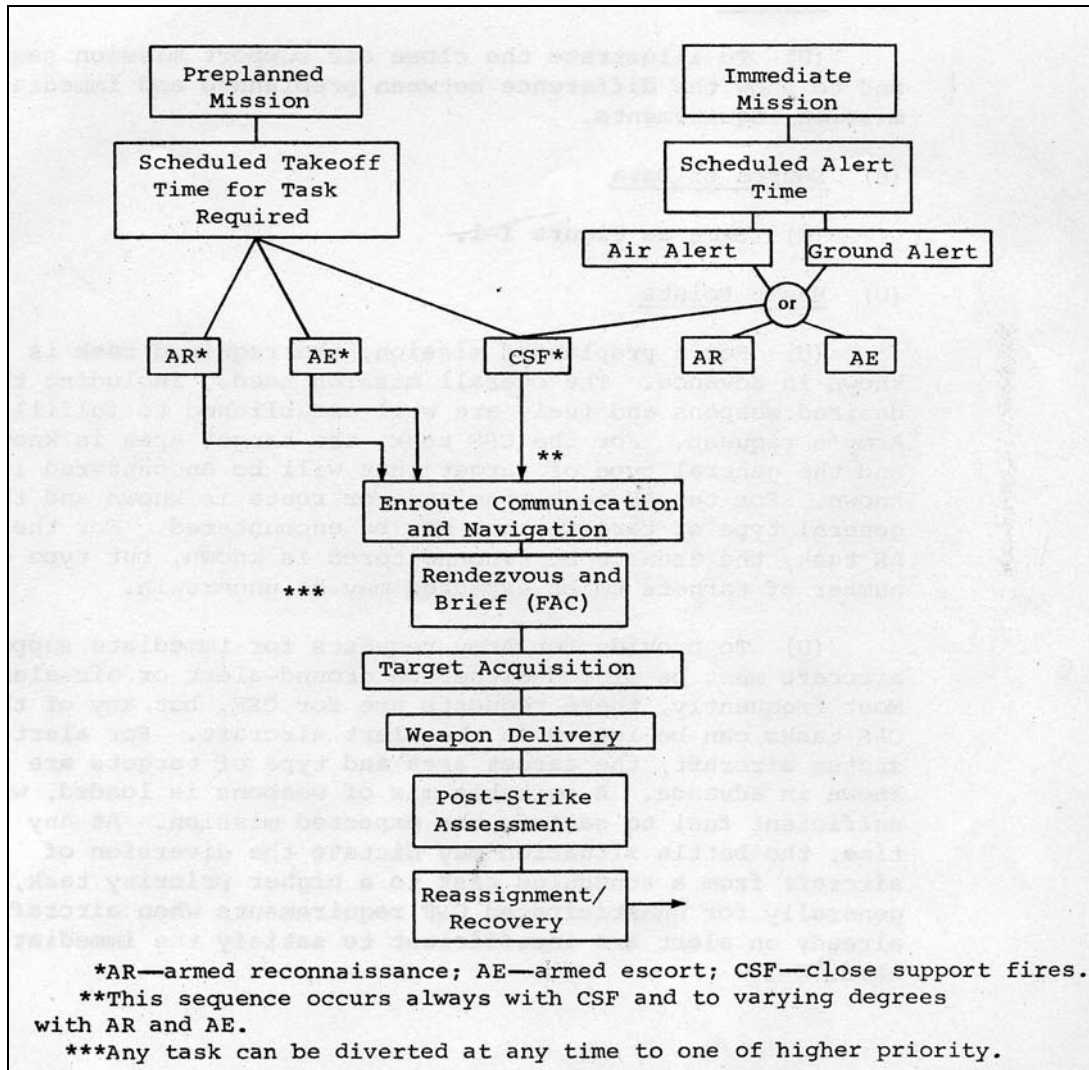
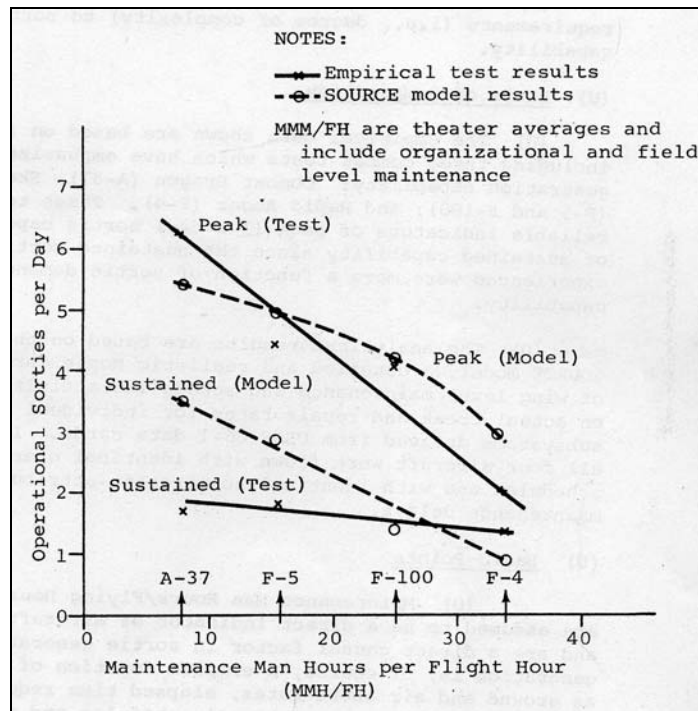

Figure 10. Close Air Support Mission Sequence<sup>39</sup>



**Figure 11. Sortie Rates for Aircraft in SEA<sup>40</sup>**

Historical analysis of ground fire attrition in World War II, Korea and Vietnam was used to determine which aircraft equipment was most vulnerable and/or likely to lead to loss of an aircraft due to ground fire. The known causes included engine, controls, structure, pilot and fire. The CFP identified design emphasis that could reduce the loss rates. These design features were:<sup>41</sup>

1. Fuel can be protected from fire and kept from ignition sources.
2. Manual controls can be made practically invulnerable.
3. Crew compartments can be sufficiently shielded and armored to make pilot losses insignificant.
4. Engines can be shielded, fire protected, and made almost fully redundant. Their oil supplies can be protected.

Maneuverability was also identified as a component of survivability, and the effects of speed and maneuverability were analyzed against probability of aircraft loss for a range of delivery profiles and threat systems. The performance requirements most important for short range attack were low cruise speed with combat loads, and both high instantaneous and sustained g-limits for initiation and execution of short radius turns without losing altitude. Superior low speed maneuvering and dive capabilities were shown to enhance close-in fast re-attack tactics, allowing operation in visibility half or less than that required for high speed jet aircraft. The importance of this on the A-X availability due to weather conditions can be seen in Table 6. High speed jet aircraft required minimums of 2000 ft cloud ceiling and 3 mile visibility for safe operations, while the A-X was expected to operate with minimums of 1000 ft/1 mile.



**Table 6. Availability of Weather Suitable for CAS Operations<sup>42</sup>**

Percent of time minimums better than—		
<u>2,000 ft./3 miles</u>		<u>1,000 ft./1 mile</u>
82%	SEA	95%
62%	Europe	86%
78%	Korea	88%
81%	(5 Theater Average)	94%

Lethality studies, in addition to addressing weapon types and load-outs, analyzed the accuracy of tracking and delivery as it related to speed, dive angles, and airframe stability. The A-X needed to be capable of stable deliveries in the region of 200-300 knots and at dive angles up to 50-70 degrees. This would allow first pass delivery with CEP<sup>xvii</sup> of 100 feet, and a CEP of 50 feet under multiple pass conditions. Simulations with pilots using a ground simulator demonstrated the relation between delivery accuracy and common stability derivatives used in aircraft control system design.

Each of four contractors awarded study contracts in May 1967 submitted design approaches in support of the Concept Formulation Package. These design studies considered a range of design choices in: 1) Airframe and Propulsion; 2) Avionics; 3) Armament; and 4) Survivability Provisions. The performance regime specified for the A-X posed no stringent requirements on the airframe, and conventional aluminum airframes were recommended by all contractors. There was more variation in propulsion options, but all contractors recommended either turboprop or turbofan engines, either in single or twin engine configurations. Engine availability investigations by the Air Force determined there were no suitable turbofan engines that could meet the required IOC, and even excursion investigations that removed the IOC constraint favored the use of turboprops. The reason for this conclusion was that the available thrust from the turboprop exceeded that of the turbofan at all speeds up to approximately 400 knots. The primary operating regime of the A-X existed below this value. The configurations recommended by the A-X study contractors appear in Appendix E. Vertical and Short Take-off and Landing (V/STOL) configuration concepts were considered by several of the study contractors, but were not considered an appropriate choice for the A-X due to inferior performance, high cost, and development risk, especially with the current IOC objective.<sup>43</sup>

The A-X study contractors were required to provide parametric design analyses based on a standard set of instructions. The parametric studies were then used to define measures of merit for evaluation of the various airframe/propulsion combinations. These measures of merit were divided into two categories: maneuverability characteristics, and payload/loiter/radius capabilities when operated from runways of varying length. For maneuverability, the best available measure was determined to be Specific Excess Power (SEP), a quantitative measure of the ability of an aircraft to climb and/or accelerate when flying at a specific airspeed, altitude and

<sup>xvii</sup> Circular Error Probable (CEP) is a common weaponeering term which refers to the radius within which 50% or more of the rounds would fall for a given delivery profile.

load factor. These parametric studies were to be used in Contract Definition to determine the levels of performance desired and technically feasible for the A-X. It was shown that the maneuverability specifications were far more critical than those dealing with radius/payload/loiter characteristics. The studies were inconclusive regarding power loading and the proper airframe-engine match. A remaining task was to establish a proper set of SEP goals to strike a balance between high and low-speed performance, and between turning and level acceleration.

An entire section of the CFP was devoted to a comparison of the A-X to existing candidate aircraft in terms of mission performance parameters and cost effectiveness. Table 7 shows some of these comparisons. Of note, the A-X external load capacity had doubled from the required amount at the start of concept formulation without a significant growth in the empty weight of the aircraft. The trade studies had shown that the twin turboprop designs combined with increased wing area produced substantial benefits, and consideration of “growth” engines in development improved the designs further (with some attendant increase in unit flyaway cost). The CFP comparisons clearly showed the benefit of a specialized design for a CAS aircraft, and none of the candidate aircraft could match the predicted A-X performance. Other comparisons showed significant improvements for the A-X in terms of target kills/sortie as it equaled or typically beat all other candidates for all missions considered. In a force cost analysis, the A-X had the lowest total force cost due to the small force required, which could be traced to high availability over the battlefield, high sortie rates, and high sortie effectiveness.

Coincident with the CFP development, Air Force Systems Command had established a Close Air Support Gun System Study Group staffed from the Armament Laboratory and the Cost Analysis Division of the Armament Development and Test Center at Eglin AFB, FL. All the A-X study contractors had recommended a large caliber internal gun, and the 30 mm projectile showed significant advantages over smaller caliber rounds. The study group awarded four gun system study contracts in early 1968 to Philco-Ford, GE, TRW, and Harvey Engineering Laboratories. All but Harvey recommended a 30 mm variant, and Harvey’s recommendation of a 57 mm recoilless rifle was rejected by the Gun System Study Group because of its low rate of fire and attendant low kill probability. The study group favored using depleted uranium rounds because the higher density shells offered greater penetration and had inherent pyrophoric characteristics, which increased the probability of secondary ignition inside tank turrets. The Gun System Study Group published its final report in September 1969, recommending a 30 mm internally-mounted Gatling gun system together with a family of associated rounds developed especially for close air support.<sup>44</sup> The Munitions Division of AFSC recommended a prime/subcontractor approach to the development of the gun ammunition to assure system integration with minimum problems.

**Table 7. Candidate CAS Aircraft Characteristics<sup>45</sup>**

	<u>A-1J</u>	<u>OV-10</u> <u>(Impr.)</u>	<u>A-37B</u>	<u>A-X</u>	<u>A-7D</u>	<u>F-4C</u>
Operating weight empty (lb) (includes crew, gun, ammunition)	13,328	9,440	6,200	20,140	19,250	31,097 w/gun pod*
Internal fuel capacity (lb)	2,280	3,680	2,974	7,000	9,750	12,818
External load capacity—with FIF (lb)	9,392	4,394	4,826	16,860	14,000	14,085
Maximum TOGW (lb)	25,000	17,514	14,000	44,000	43,000	58,000
Engines (number/type)	one R-3350	two T-76	two J-85	two T-55	one TF-41	two J-79
Useful load capacity (fuel and ordnance—lbs) for takeoff distance (Ground Run, S.L., Tropic Day) of:						
	750 ft	4,000**	1,300**	3,200**	9,000	-0-
	1,000 ft	6,200**	3,600	4,000**	12,500	-0-
Maximum speed, clean, S.L. (KTAS)	277	262	417	400	607	M 1.2
Best cruise speed, 5,000 ft, maximum ordnance (KTAS)	170	170	265	240	315	420
Ferry range, unrefueled (NM)	2,800	2,600	1,560	2,600	2,600	1,600
Number of ordnance stations	15	7	8	10	8	5
Internal guns (number/caliber)	four 20-mm	four 7.62-mm	one 7.62-mm	one 30-mm	one 20-mm	*(one SUU-16 20-mm pod)

\*\*Cannot land in this distance at any weight.

### 3.2.5 Contract Definition

Secretary of the Air Force Dr. Harold Brown submitted the CFP to the Secretary of Defense on 17 Jun 1968, requesting permission and funding to enter into Contract Definition. From the late FY71 date in the CFP, the IOC date was slipped into FY72 in an August 1968 Air Force Program Change Request. The office of the DDR&E prepared a Development Concept Paper (DCP) which was submitted to the Deputy Secretary of Defense in December 1968. Four management sub-issues were spelled out in the DCP:<sup>46</sup>

1. Would an appropriately modified, existing aircraft meet the requirement?
2. Should the initial development be a single-place A-X with minimum avionics for visual attack only, or should concurrent development proceed with a two-place version equipped with avionics for night/adverse-weather close support?
3. Should competitive prototypes be developed and flown before selecting the basic A-X configuration?
4. Should the A-X be bought instead of some of the already programmed A-7s or F-111s, or, as the Air Force proposed, as an addition to the tactical Air Force structure?

Entry into Concept Definition was not approved as the Air Force initially requested. Dr. John Foster, DDR&E, recommended that the concept formulation studies be continued, but the initial advanced development of the CAS gun system should begin in FY69. He questioned the survivability of the A-X against heavier defenses (the CFP emphasized survivability against small arms defenses) and wanted to wait for additional data and test results on the A-37, OV-10, and A-7. Dr. Foster stated that “the proposed aircraft seems to be too large, and has too much range/payload at this early stage. It is so similar to A-7 that it is hard to justify when we already have A-7. A smaller, less costly, quick reaction aircraft seems more appropriate.”<sup>47</sup> After reviewing the DCP, the Deputy Secretary of Defense approved \$12M in the FY70 budget for Contract Definition, contingent on the Air Force’s completion of supplemental studies addressing the size and weight of the A-X, survivability of the A-X in the anticipated threat environment, and methods to improve the aircraft night and adverse weather capability.<sup>48</sup>

The Air Force reestablished the A-X Working Group with the intention of completing the CFP supplements by May 1969. Air Force Systems Command was also to provide a Technical Development Plan (TDP) to accompany the CFP supplements and address additional issues necessary for approval of Contract Definition. On 22 September 1969, the Air Force forwarded the three supplements to the CFP to the OSD. The DDR&E prepared a draft revised Development Concept Paper, DCP-23A, completed in December 1969. The Defense Systems Acquisition Review Council (DSARC) met on 19 December 1969 and raised questions with regards to discrepancies between the Air Force and the Office of the Assistant Secretary of Defense for Studies and Analysis (OASD (SA)) cost estimates. Army representatives raised concerns regarding the affordability of another major tactical aircraft program, and the sufficiency of the A-X to meet needs for night and all-weather operations. Dr. Foster issued tasks to resolve the remaining questions, and the results of the tasks would be used to update the DCP-23A.

The final version of DCP-23A, dated 16 March 1970, contained three management sub-issues, but they were essentially the same as those from the original DCP-23, differing only in wording and number. The issue of tactical force mix had become even more troubling to OSD since, in FY70, the A-7, F-4, and F-111 were all in production, and the F-111 was consuming close to half of the Air Force’s tactical fighter aircraft funding. Further, the Air Force had just awarded a development contract to McDonnell Douglas for the F-15. The A-X fared well in a force mix analysis for conflicts where air superiority was not necessary, but for a high intensity conventional war (e.g., the envisioned war in Europe) the demand for air superiority/interdiction was considered critical, making it difficult to justify reducing the numbers of multi-role aircraft in favor of A-X acquisition.

One result of the delay from DCP-23 to DCP-23A was the emergence of support for competitive prototyping as opposed to the more conventional Contract Definition approach. Robert McNamara, who was Secretary of Defense from 1961 to early 1968, was opposed to competitive prototyping so it had fallen out of favor during his tenure. After McNamara’s resignation proponents of the approach became more vocal and gained support. General James Ferguson, AFSC Commander, favored competitive prototyping, and while Dr. Foster maintained the necessity of paper analysis, he conceded the utility of competitive prototyping for reducing technical risk.<sup>49</sup> The new Deputy Secretary of Defense, David Packard, established panels to

look at cost growth in systems acquisition and concluded that the Defense Department would benefit by a “judicious increase” in hardware demonstration and competition, with a subsequent reduction in dependence on paper analysis. With these changes afoot, The Air Force developed four new program schedules with associated costs as part of the TDP being prepared. Three of the four schedules were associated with a prototyping approach. In October 1969, Secretary of the Air Force Harold Seamans chose an alternative that was termed “Parallel Undocumented Development”. This approach would require a minimal amount of documentation during the competitive prototype phase to encourage innovation and initiative on the part of the contractors.<sup>50</sup> While it was expected that the competitive prototyping phase would reduce technical risk and lead to a better source selection decision, it increased the expected RDT&E costs from \$155.1M to \$194.0M.

Three alternative recommendations were put forward in DCP-23A:

Alternative IA: Approve development of the A-X aircraft via a normal Contract Definition backed by an appropriate parallel program in avionics and ordnance.

Alternative IB: Approve development of the A-X via a competitive prototype flyoff backed by an appropriate parallel program in avionics and ordnance.

Alternative II: Disapprove development of a new A-X aircraft at this time but continue to upgrade sensors and ordnance for use in conjunction with existing aircraft.

The parallel program specification in alternatives IA and IB reflected the Army’s continued concern over the night and adverse weather capability of the A-X. On 6 April 1970 Deputy Secretary of Defense Packard approved Alternative IB.<sup>xviii</sup> A proviso associated with Packard’s decision stated that there would be “future discussions with AF & Army on cooperation in this program and coordination with the AAFSS program.”<sup>51</sup> It was clear that there was significant overlap in the projected capabilities of the A-X and the AH-56 helicopter, and the Air Force and the Army had not been able to agree as to how they would both fit in or be necessary given the roles and missions for CAS. The two services had jointly recommended funding both systems through prototype development, but it was becoming clear that tougher choices were going to be necessary.<sup>xix</sup> Further complicating the situation, the Marine Corps wanted its own CAS aircraft, the Vertical and Short Take-off and Landing (V/STOL) AV-8 Harrier.

Table 8 shows cost, schedule and aircraft characteristics comparisons associated with DCP-23 and DCP-23A. The representative A-X from the DCP-23A was slightly smaller, lighter and cheaper than that of DCP-23. The delay associated with DCP-23A and the change to a competitive prototyping approach had a significant effect on IOC, with the new projected IOC now in FY75.

---

<sup>xviii</sup> Of note, the sole dissenting recommendation on DCP-23A was the Secretary of the Navy who recommended Alternative II. Stated reasons were lack of night and all-weather capability, and no Navy/Marine Corp requirement for a single mission aircraft. Survivability and cost realism were also considered questionable.

<sup>xix</sup> Interestingly, the Army had awarded a production contract for 375 AH-56 helicopters in 1968; however, the production was canceled the following years for default by the contractor. The Army concluded that aircraft delivered on the contracted schedule would not meet speed and maneuverability specifications. Nonetheless, the Army continued the development effort on the AH-56 for several more years.

**Table 8. Changes in the Representative A-X Associated with DCP-23A<sup>52</sup>**

COST, SCHEDULE, AND CHARACTERISTICS COMPARISONS		
	First DCP (#23) 11 Dec 68 Alternatives 1 and 2	Second DCP (#23A) Feb 70 Alternative IB
<u>Cost:</u> (Millions of 1970 \$)		
Total Program Cost, 10 yrs	2536	2180
RDT&E	137	194
Production Cost (including initial spares)	1169	831
No. of production aircraft	723	600
10 year O&M, 5 wings	1230	1155
<u>Schedule:</u>		
Contract Definition Start	Mar 69	Mar 70
Award Development Contract	Feb 70	Jul 70
First Flight	Dec 71	
Competitive Flyoff		Apr 72
Award System Contract		Jun 72
IOC (first squadron)	Mar 73	Feb 75
<u>Significant Program Characteristics:</u>		
Operating weight empty (lbs)	20,140	19,925
Maximum gross weight (lbs)	44,000	38,000
Cruise speed, kt	300	300
Usefull load, (operating from 1000 ft airstrip), lb	6,500	6,500
Loiter time at 250NM radius, 18 MK82, hours	2	2
Bombing accuracy, MK82, CEP, ft	112	112
Strafing accuracy, CEP, mils	10	10
Sustained load factor, 6 MK82, 275 kt, g	3.8	3.5
Maintainability, manhours/flt hr	12	12

A positive effect of the delay had to do with the technology maturation associated with the engines. In the mid 1960s, both GE and Lycoming had been experimenting with high bypass ratio turbofans, and a big boost for the technology came in 1965 when the Air Force selected the TF39 engine to power the C-5 Galaxy heavy lift aircraft. Still, there was no proven turbofan engines in the size and thrust class required for the A-X during this time, so turboprops continued to be favored. In 1966, the Navy selected a new turbofan engine design, the GE TF34, as part of the development effort for the S-3 Viking anti-submarine aircraft. This provided development funding for GE to mature the design and build and test the new engine. By 1970 the development effort was bearing fruit, and it became clear that the potential for a twin turbofan design for the A-X existed. This resulted in direction to industry to consider turbofan configurations. The expected benefits of the high bypass turbofan for the CAS role were as follows:<sup>53</sup>

- Simplicity of design. No propeller and no reduction gear, or, at least, a much smaller or simpler system;
- Ease of maintenance, vital in the battlefield and for optimum sortie rates;

- Ease of installation, being modular in design, and ease of access;
- The high-bypass turbo was relatively quiet compared with the propeller or conventional jet engine;
- Affordability: cheap to purchase, cheap to run, cheap to replace;
- Reduced IR signature;
- High thrust at low speed, enhancing maneuverability.

### 3.3 Program Formulation

#### 3.3.1 Request for Proposals

The Air Force received the System Management Directive authorizing the A-X program on 10 April 1970. The Aeronautical Systems Division (ASD) of Air Force Systems Command (AFSC) officially established an A-X SPO on 27 April 1970 within the Deputy for Systems Management.<sup>xx</sup> In keeping with the philosophy of minimum documentation for the Parallel Undocumented Development phase, the SPO was to be manned on an austere basis.<sup>54</sup> The Parallel Undocumented Development phase permitted a large degree of contractor freedom, and many management and technical reporting requirements were deleted. The desired outcome was greater initiative, inventiveness, and competition among the contractors, and the Air Force would be able to defer the costly commitment to production until more complete design and cost data became available from the prototyping phase.

The A-X Request for Proposal (RFP), including all attachments and “boiler plate”, was 104 pages, and it limited each contractor’s response to 585 pages. This represented a sizable reduction in the RFP for its time, and Deputy Secretary of Defense Packard considered it a “major breakthrough” made possible through the use of competitive prototyping, and indicated it was the direction he wanted the Defense Department to go.<sup>55</sup> Two crucial goals in the RFP were achievement of weapon system effectiveness, and low costs. The RFP established a design-to-cost goal of \$1.4M unit flyaway cost (FY70\$) for a 600 aircraft buy. The system requirements in the RFP were for the production aircraft, and were to be achieved in the prototype aircraft on a “best effort” basis by the contractors. The Competitive Prototype Phase (CPP) was to be a 26 month effort during which two contractors would design, develop and fabricate two prototype aircraft for flight test and Air Force evaluation. The contract type for the CPP would be firm fixed price. Contractors would have 3 months to respond to the RFP, and the government intended to complete its evaluation of proposals and make awards within a 75 day period.

Twelve companies were selected to receive the RFP upon its release on 8 May 1970, and on 7 August 1970 six companies responded with proposals. The responders were Fairchild Hiller, Boeing, Northrop, Cessna, General Dynamics and Lockheed Aircraft. Table 9 shows the proposal summary from the resulting source selection briefing to the DSARC, and Appendix F provides aircraft configurations and performance summaries for the contractor proposals. Of note, almost all proposals represented larger aircraft than spelled out in the CFP, and four of the six proposals intended to use the GE TF-34 turbofan engine, with a fifth proposal specifying it as a backup. By 1970, the TF-34 was promising approximately 9,000 lbs of thrust, more than twice

---

<sup>xx</sup> Initially an A-X SPO had been established under the Deputy for Development Planning in May of 1968 when the Air Force anticipated approval of the original CFP. Manning for the SPO reached a high of 22, but was gradually reduced to only 3 people by May 1969 due to delays in program approval by OSD.

the thrust of the GE CF700 turbofan engine that was investigated during the early concept studies. Only Boeing proposed a turboprop design, and the evaluation noted “potentially significant development problems with the gearbox and cross-shafting.”<sup>56</sup> The Lockheed and Cessna proposals were eliminated relatively early on; the Lockheed design was considered too big and expensive, and the Cessna design was considered “preliminary and incompletely designed”. The Source Selection Evaluation Board, chaired by Colonel James Hildebrandt (A-X Program Director), completed their evaluation and by late October 1970 Secretary Seamans was briefed on the results. The DSARC was briefed in December 1970 and expressed concern that both winning proposals exceeded the DCP-23A cost baselines for RDT&E and production. In order to reduce these costs the Air Force was to provide guidance stressing simplicity of design, ease of maintenance, and the importance of keeping costs of the A-X to a minimum. The contractors were to be warned that unless production costs were close to the \$1.4M goal the A-X program might not be approved for the follow-on development and acquisition. In order to achieve cost savings, the specified performance requirements were not to be considered firm specifications, but goals “to the extent they are economically feasible.”<sup>57</sup> The winning contractors, Fairchild Hiller and Northrop, were announced publicly on 18 December 1970.

Northrop and Fairchild Hiller each signed firm fixed price contracts to provide two prototypes each for the competitive phase of the A-X program. Northrop received \$28.8M for the effort, while Fairchild Hiller’s Republic Division received \$41.2M. Part of the reason for the difference in amounts was the larger aircraft and more expensive engine (TF-34) associated with the Fairchild proposal. This was the first Air Force development program governed by design-to-cost principles, and these would be tested from the outset by both contractors. The Air Force gave them wide latitude in making cost/performance trades, specifically with regards to instantaneous g’s, takeoff distance, combat radius/loiter, maximum payload and ammunition capacity.<sup>58</sup>

**Table 9. A-X Proposal Summary**

PROPOSAL SUMMARY							
	CFP	FAIRCHILD	BOEING	NORTHROP	CONVAIR	CESSNA	LOCKHEED
OPER. WT. EMPTY LBS. (MAX TOGW LESS USEABLE FUEL AND BOMBS)	17,820	25,735	20,318	21,030	20,678	20,634	30,620
MAX. GROSS T.O. WT.	38,000	45,825	36,330	39,570	38,262	40,102	50,000
WING AREA SQ FT	480	600	443	560	380	600	675
WING SPAN FT	51	55	52	57	48	66	71
ENGINE	—	TF-34	T-64	TF-55 TF-34	TF-34	TF-34	TF-34
CPP PROPOSAL \$	28.0	41.2	37.0	28.9 28.9	37.7	28.5	58.4
PROD. UNIT FLYAWAY \$	1.17	1.327	1.346	1.162 1.302	1.371	1.258	1.448

### 3.3.2 Program Initiation for the CAS Gun System

AFSC forwarded the recommendations of the CAS Gun System Study Group to the OSD in the fall of 1969, and on 5 June 1970, the DDR&E issued Development Concept Paper #103, entitled “Close Air Support Gun”. DCP-103 generally confirmed the study group’s findings, but



raised questions associated with foreign candidate gun systems, joint service use, and the possibility of a program delay to allow for advanced technology. The Swiss-made Oerlikon 304RK 30 mm had been rejected by the study group for a low rate of fire and low reliability, and the Vehicle Rapid Fire Weapon System-Successor (VRFWS-S) proposed by the Army was unacceptable because previous efforts to use a similar sabot round system<sup>xxi</sup> for airborne application had resulted in sabot ingestion by the turbine engines. Joint service use proved elusive as the proposed CAS gun was too big for Navy fighters, and the 30 mm shell was not big enough for army applications where penetration of thicker side armor was required. The DDR&E recommended proceeding with a 33 month competitive prototype development phase for the proposed gun, but not without the dissent of both the Secretary of the Army and Secretary of the Navy. Packard approved the proposed prototype development pending confirmation of Air Force estimates by the Joint Technical Coordinating Group (JTTCG) for Munitions Effectiveness. The JTTCG provided that confirmation in a summary report dated 3 December 1970.

The Armament Development and Test Center released an RFP for a competitive prototype development effort on the CAS gun system in April 1971.<sup>xxii</sup> This resulted in the selection of two contractors, GE and Philco Ford, to enter the competitive phase. DDR&E continued to have reservations with how the gun program would support the A-X development and test schedule. In particular, he noted that the new CAS gun system would not be ready for evaluation on the A-X prototypes during the competitive flyoff, and he did not think testing the prototypes with the 20 mm M-61 gun could be extrapolated to predict performance with the 30 mm gun system. The Air Force revised the gun program in October 1971 to allow for testing of the winning gun system in the winning A-X aircraft prior to a production decision.

Lingering concerns remained regarding the elimination of the Oerlikon 304RK gun from consideration. DDR&E believed that, since it had been in existence for 10 years, it represented a lower cost, lower risk alternative. Internal Air Force and independent Air Force Scientific Advisory Board studies had both concluded that it would not be cost effective in the long run due to low reliability and high maintenance costs. Nonetheless, DDR&E persisted and the Air Force eventually agreed to test the Oerlikon gun. The resulting agreement was to test the utility of the Oerlikon 304K by April 1973, and it would serve as an alternate gun system should both GE and Philco Ford fail to demonstrate an adequate gun system for the A-X. The Oerlikon 304RK was designated by the Air Force as the GAU-9/A, effectively removing it from the competitive development effort to build what was designated the GAU-8/A.

Each of the two competitors for the GAU-8/A signed a firm fixed price contract for the competitive phase of development. The contract called for prime contractor responsibility for gun system integration, and each contractor was required to deliver three guns with link less feed and storage system, electronic control unit, and a family of combat and target practice ammunition. The ammunition development, which was subcontracted, consisted of rounds for target practice, high explosive incendiary, semi-armor piercing high explosive, and armor

---

<sup>xxi</sup> A sabot is a shoe or sleeve used in a cannon or gun to fire a projectile smaller than the bore diameter.

<sup>xxii</sup> An earlier RFP was actually released in October, 1970, but none of the four proposals received were considered acceptable. The best gun design had the worst ammunition, and a mismatch of proposed contract types prevented any meaningful comparison.

piercing incendiary with steel penetrator. Concurrently, the Los Alamos Scientific Lab and AAI Corporation began joint development of an armor piercing incendiary round with a depleted uranium penetrator. The Air Force placed great importance on both performance and cost considerations for the ammunition. Beyond concerns for the ability to penetrate heavy armor, a study done at Eglin AFB during this time frame highlighted the importance of ammunition cost. With respect to existing aircraft guns, the report stated: "Research and Development accounted for only 1% of the total funds expended over the life of a gun system. Ammunition for over 90%, gun investment for 4%, and operation and maintenance for 5%."<sup>59</sup>

The Air Force understood that the fortunes of the A-X and the GAU-8/A were intertwined, and recognized the importance of the integration effort given four prime contractors, two each for the aircraft and the gun. It was clear by then that aircraft would be designed to accommodate the gun, instead of the gun being chosen to "fit" in the aircraft. A memorandum of agreement was signed on 15 October 1971 between the Aeronautical Systems Division and the Armament Development and Test Center designating both the A-X SPO and the Air Force Armament Laboratory as responsible for both the management and development of the GAU-8/A gun.<sup>60</sup> Overall management responsibility was given to the A-X SPO, and the Armament Laboratory was responsible for technical/engineering support for the GAU-8/A gun system. A GAU-8 Program Manager, located in the Armament Laboratory, was the focal point for support to the A-X SPO. This memorandum of agreement would be expanded in September 1973 to include the 30 mm ammunition development programs.

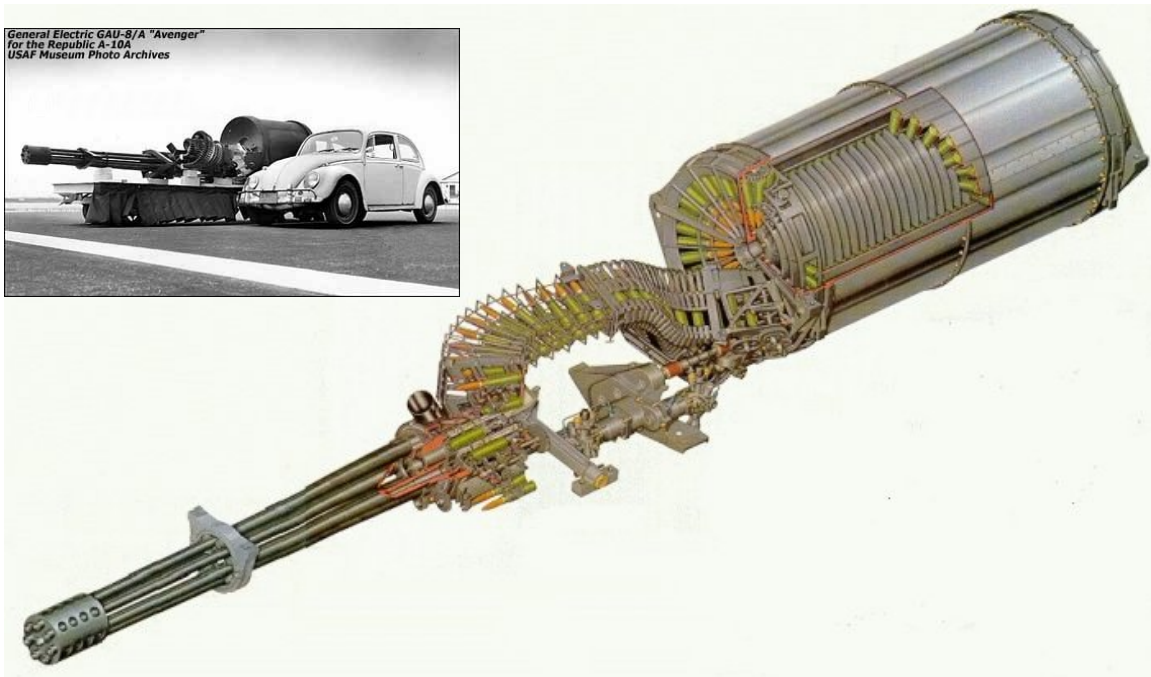

**Figure 12. The GAU-8/A Gun System**

## 3.4 Parallel Undocumented Development – The Competitive Prototypes

### 3.4.1 Program Office Activities

The small A-X SPO (only about 30 personnel) had large areas of responsibility. In addition to the competitive prototyping of the A-X, they were responsible for the GAU-8/A development, and were monitoring parallel development for avionics and the two engines. The engines were to be provided as Government Furnished Equipment (GFE), so in 1972 the Air Force would award contracts<sup>xxiii</sup> to both Lycoming (for the F102 engine) and GE (for the TF34 engine).<sup>61</sup>

Specific ground rules were established by the Air Force to ensure fair competition during the competitive prototype phase. Performance goals were established by the Air Force Headquarters, and revisions to those goals could only result from joint contractor SECAF-appointed panel discussions. There was to be no communication between the contractors, and the SPO would provide equal distribution of information to them. The contractors were authorized to initiate design changes they deemed necessary as long as these changes were in the context of the specifics of the contracts.<sup>62</sup> The Air Force designated the two contractor's designs as the A-9A (Northrop) and A-10A (Fairchild).

### 3.4.2 The Prototypes

The A-9A was a twin turboprop aircraft using the non-afterburning YF102 engines rated at 7500 lbs of thrust per engine. It was a high wing design with the engines located under the wing root adjacent to the fuselage (see Figure 13.) The lower thrust YF102 engine cost less than the TF34, but the lower thrust required an increase in wing span to meet the low-speed maneuvering and take-off distance requirements.<sup>xxiv</sup> The design-to-cost goals were evident not only in the selection of the lower cost engine, but in the selection of off-the-shelf equipment such as the main landing gear struts from the McDonnell Douglas A-4, wheels and brakes from the Grumman Gulfstream 2, nose landing gear from the Northrop A-5, and ejection seat from the McDonnell Douglas S-3A. Further evidence of attention paid to production cost was the use of interchangeable left and right side parts for engines, control surfaces, and other parts.

Survivability features of the A-9A included redundant critical structural members, access doors designed to blow out in the event of an internal explosion, redundant hydraulic flight controls with manual back-up, foam filled and self sealing fuel tanks, and a “bathtub” of armor plating around the cockpit. Maintenance features included chest high engine placement for ease of ground-level service; Northrop engineers speculated that an engine replacement could be accomplished in 30 minutes.<sup>63</sup>

---

<sup>xxiii</sup> The Lycoming contract was a cost-plus-incentive-fee effort for development through qualification testing of the F102 turboprop engine. The GE contract was a fixed-priced-incentive-fee effort for only qualification testing of the TF34 engine as it had already been developed for the Navy S-3 aircraft.

<sup>xxiv</sup> The YF102 also required further development as compared to the TF34, so the TF34 was selected as the backup option for the Northrop design.



**Figure 13. The YA-9A Prototype**

The A-10A was also a twin-engine turbofan design, with the biggest difference between it and the A-9A being the placement of the wing and engines, and the tail configuration (see Figure 14.) The TF34 was a non-afterburning turbofan rated at over 9,000 lbs of thrust, and the engines were placed above and behind the wing in pods attached to the outside of the fuselage. The high placement of the engines reduced the chance of Foreign Object Damage (FOD) during take-off and landing, and also enabled rapid mission turn around on the ground as the engines could be left running while rearming. The rearward placement of the engines reduced the IR signature as the exhaust from the engine was partially shielded from view by the tail. The low wing allowed for ease of store loading, and also allowed wing mounted landing gear for a wider track and better stability on rough forward area landing strips.<sup>64</sup> Fairchild also used interchangeable left and right side parts for cost control. Survivability features included redundant hydraulic flight controls with mechanical back-up, a titanium “bathtub” around the cockpit, twin vertical stabilizers, foam filled self sealing fuel tanks, and main landing gears that partially protruded from nacelles on the wings making gear-up landing less hazardous. “The aircraft is designed to fly with one engine, one tail, one elevator and half a wing torn off.”<sup>65</sup>

On 10 August 1972, the Air Force released proposal instructions for the continued development and testing of the CAS aircraft. Each of the contractors submitted technical and cost proposals in October 1972 which were to be used with the results of the competitive fly-off to select the single contractor that would go forward with advanced development.



**Figure 14. The YA-10A Prototype**

### **3.4.3 Competitive Fly-offs and Shoot-offs**

The YA-10A made its first flight on 10 May 1972, approximately 17 months after contract award. The YA-9A made its first flight 10 days later. (See Figures 15, 16.) Between May and October 1972 the contractors flight tested their aircraft, accumulating 162 hours on the YA-9A and 190 hours on the YA-10A. The fly-off between the two aircraft was conducted at Edwards AFB, CA between 10 October and 9 December 1972. “During this period the A-9A crews flew 123 sorties for a total of 146 flight hours and the A-10A was flown 87 sorties for a total of 138.5 flight hours.”<sup>66</sup> Both aircraft utilized an internal M61 20 mm Gatling Gun in place of the developmental GAU-8/A which was not ready for testing. The fly-off was intended to task the aircraft with difficult flying conditions in order to magnify the differences in design. While not a primary goal of the fly-off, weapon delivery accuracy was evaluated and both aircraft were found to perform adequately with only minor differences between them.



**Figure 15. YA-9A Flight Test**

With little performance differences between the two aircraft, the source selection decision rested on other factors. The A-10 was judged to have better ground handling capability – a result of the low wing design and more ordnance space on the larger wing. The Air Force also believed the A-10 to be closer to production, thus allowing for faster progress in the test program.<sup>67</sup> Other comments made at the DSARC review included Secretary Seamans statement to the effect that the simpler design of the A-10 was more likely to allow achievement of the \$1.4M unit flyaway cost, and DDR&E Foster commented that the pilots who had flown both prototypes preferred the A-10 for combat operations.<sup>68</sup> On 18 January 1973, Deputy Secretary of Defense Kenneth Rush authorized the Air Force to make a source selection announcement, and also directed the OSD Cost Analysis Improvement Group (CAIG) to estimate the cost of the entire remaining program. The CAIG presented the results of its review to the DSARC on 8 February 1973. They estimated a unit flyaway cost of \$1.7M (FY70\$), with an uncertainty range of \$1.5M to \$2.0M. The SPO estimate was \$1.5M, while the contractor estimate was \$1.4M. The DSARC recommended approval of the full scale development contract and a design-to-cost goal of \$1.5M total flyaway cost (recurring prime mission equipment cost plus SE, program management, and system test and evaluation) with contractual incentives to achieve or come under the cost goal. The resulting procurement program, however, was based on the CAIG's most probable cost of \$1.7M. The Deputy Secretary of Defense approved full-scale development of the A-10 on 28 February 1973, and on 1 March the Air Force awarded a cost-plus-incentive-fee contract for approximately \$160M. On the same day GE was awarded a fixed-price-incentive-fee contract for approximately \$28M to develop and deliver 32 TF34 engines.<sup>69xxv</sup>



**Figure 16. The YA-10A on Landing**

---

<sup>xxv</sup> Notably, the showdown between the Army and the Air Force with regards to competition between the AH-56 Cheyenne and the A-X never came to a head. Lockheed encountered major development problems with the AH-56, and a Senate report in 1972 recommending funding for the A-X and the Marine AV-8 (but not the AH-56), effectively ended the program. By the end of 1972, the Army had already issued an RFP for a new anti-armor attack helicopter which would eventually see service as the AH-64 Apache.

Shortly after the competitive A-X fly-off, the GAU-8/A “shoot-off” between GE and Philco Ford began. The gun competition was conducted at Eglin AFB from 3 January to 6 April 1973. Air Force evaluation teams fired and maintained the guns, with contractors acting only in an advisory capacity. Each contractor supplied three guns (two for evaluation, one for backup and spare parts) and 100,000 rounds of Target Practice ammunition. The programmed test called for 70,000 rounds to be fired for each design – 35,000 rounds each for the two guns supplied for testing by each contractor. The GE supplied guns fired over 70,000 rounds, but the Philco Ford guns fired less than 16,000 rounds due to repeated jamming. The GE guns averaged 8,800 rounds between failure, while the Philco Ford guns averaged only 728. The GE design met or exceeded the performance expectations in all areas except weight. The gun weight increased from 367 to 591 lbs, and the total system weight from 2607 to 3885. Despite this weight growth, the GE design was declared operationally suitable and GE was declared the winner of the prototype competition.

GE handily beat Philco Ford in the GAU-8/A competition, but still had to wait for conclusion of the test firings of the Oerlikon 304RK gun (designated the GAU-9/A). The Oerlikon gun didn’t fare much better than the Philco Ford design. Table 10 shows the comparison of the test results for the GAU-8 and GAU-9 gun competition. The GAU-8 numbers correspond to the GE designed system. The DSARC reviewed the GAU-8/A program on 5 June 1973 and recommended proceeding with full-scale development of the gun and ammunition. On 21 June GE was awarded a fixed-price-incentive-fee contract for approximately \$24M. The contract was to deliver seven preproduction gun assemblies and to refurbish the three prototype guns. GE was also responsible for the development and limited production of a family of 30 mm ammunition. One of the provisions of the contract approval was that GE bring on a second subcontractor for ammunition development.<sup>xxvi</sup> Already teamed with Aerojet for ammunition development, GE subcontracted with Honeywell to provide a second source. Honeywell was well positioned to do this as they were subcontracted to Philco Ford for the competitive prototype development phase. The cost of the second source for the ammunition development was \$17M in RDT&E.

**Table 10. Performance Comparison of the GAU-8/A and GAU-9/A<sup>70</sup>**

<u>Characteristics</u>	<u>GAU-8</u>	<u>GAU-9</u>
Major maintenance interval	15,000 rounds	3,000 rounds
Mean rounds between failure	8,800	846
Maintenance manhours/1,000 rounds	5.9	24.3
Barrel life (rounds)	2,373 (copper bands) 6,000*(plastic bands)	748 (sintered iron bands)
Rounds on system before barrel change	16,000 (copper bands) 42,000 (plastic bands)	1,500

\*Estimated barrel life

<sup>xxvi</sup> In the milestone II review, the DSARC had expressed concern that ammunition costs, especially those associated with the armor piercing incendiary round could be held to Air Force estimates.

## **3.5 Full Scale Development**

### **3.5.1 Program Management**

Following the decision to proceed with full-scale development, the A-X SPO was re-designated the A-10 SPO, and two months after that it was re-designated the Deputate for A-10. Manning for the SPO had purposely been kept lean during the competitive prototype phase, but Brigadier General Thomas McMullen, newly promoted and named Deputy for A-10, requested organizational changes to the SPO and an increase in manpower.<sup>71</sup> Procurement and production functions were split into separate directorates, and functional divisions were established within those directorates. Manning, which had grown slightly by mid 1973 to about 60 SPO personnel and 30 co-located personnel, would double in size over the next year.

### **3.5.2 The A-10/A-7D Fly-off**

During review of the FY74 RDT&E budget in September 1973, Congress raised concerns about the A-10 production cost and its lack of versatility. The A-7D had performed well during its deployments to Vietnam, and budgets for fighters were being stretched by development and production of multiple fighter and attack aircraft for the Air Force, Navy and Marines (not to mention Army helicopters). Underpinning this concern was a rivalry between Fairchild (the A-10 contractor from Long Island, NY) and LTV Corporation (the A-7 contractor from Dallas, TX) and their congressional supporters. Congress wanted a fly-off between the A-10 and the A-7D (in production for the Air Force since 1967), but the Air Force and the OSD did not believe that a fly-off would produce meaningful information beyond what was being obtained from ongoing A-10 testing. The Air Force also stressed that extensive studies had shown the superior survivability of the A-10, and that both the A-7D and F-4 lacked characteristics they were looking for in the A-10.<sup>72</sup> The A-10 contractor was also opposed to a fly-off stating, among other reasons, concern over the “ability of anyone to convince special interest Congressmen of the need for specific flight handling characteristics for performing the close air support mission, survivability, and other close air support performance parameters, especially when they are not directly evaluated through flying.”<sup>73</sup> Nonetheless, in September 1973 the Air Force agreed to comply with Congressional recommendations.

The main point of the fly-off was to have experienced pilots fly both the YA-10 prototype and the A-7D and provide an assessment of which aircraft they would prefer in a combat environment. The new DDR&E, Malcolm Currie, and the Deputy Director of Defense Research and Engineering for Test and Evaluation (DDT&E) worked with the Weapons System Evaluation Group (WSEG) to develop guidance for the fly-off. The Air Force was to conduct the fly-off in a realistic combat environment (scenarios, terrain, weather) and the Army was to provide realistic ground equipment (targets, surrogate Air Defense systems, and related support). The flights were scheduled for the Spring of 1974 by which time the A-10 was expected to be qualified for maximum load factor at some (but not all) gross weights, qualification tests for some ordnance carriage would be complete, and limited communication equipment and the depressed reticle sight would be installed. Missing from the prototype, however, was the GAU-8/A gun, a head-up display, the Maverick missile system, and various IR and electronic countermeasure equipment. Probably because of the limitations of the prototype A-10, the DDR&E “added a second purpose to the evaluation by directing that: Using the fly-off results, together with other pertinent data, the Air Force and the WSEG will each develop for the



DDT&E an analysis of the test results and overall evaluation of the relative effectiveness of the A-7 and A-10 in close air support.”<sup>74</sup>

The fly-off was conducted between 15 April and 9 May 1974. Four experienced pilots were chosen, none of which had previously flown either the A-7D or the YA-10. The aircraft operated out of McConnell AFB, Kansas, and the ground targets and simulated air defenses were located at Fort Riley, Kansas. Fort Riley was chosen due to similarities with the European theater, and it had adequate air space and range instrumentation. The fly-off tested three aircraft configurations: heavy (12 MK 82 500 lb bombs), medium (6 MK 82's) and clean. Bomb release as well as missile release and gun firing were simulated. Weather ceilings simulated included unlimited, 5,000 ft, 3,000 ft, and 1,000 ft. Each aircraft flew a total of 160 passes over the simulated battlefields. Data collected for the flights included Range Measurement System II, Cooper Harper (handling quality) ratings, and pilot summaries.

The flight test results confirmed the Air Force's belief that a specialized close air support aircraft offered distinct advantages. While all the test pilots preferred the A-7D to the YA-10 for situations of unlimited ceiling/unlimited visibility, for low ceiling/low visibility conditions the maneuverability of the A-10 allowed them to operate and maintain visual contact with the target. The conclusion of the evaluation report was: “On the basis of the Fort Riley test, the analysis produced the observation that the YA-10 prototype was the overall more effective aircraft. This observation is based on calculations of relative lethality in the attack of targets and relative attrition to defenses experienced by both aircraft used in the test.”<sup>75</sup> With respect to the secondary purpose: “This analysis produced the observation that the A-10A will be a more effective and more cost-effective close air support aircraft than the A-7D in a combined arms conflict.”<sup>76</sup> The high cost effectiveness was a result of higher lethality, lower attrition and higher expected sortie rates for the A-10A. The report noted that the A-10A was less costly than the A-7D both in terms of acquisition cost as well as life cycle cost. Of note, the GAU-8/A gun was a significant factor in the evaluation as the 20 mm gun in the A-7D was ineffective against armored targets.

Despite emerging as the clear winner of the fly-off with the A-7D, critics of the A-10 program remained and continued their vocal opposition. Beginning in 1974, political pressure was being applied for the Air Force to consider the Piper Enforcer<sup>xxvii</sup> as a cheaper alternative to the A-10. Influential newspaper publisher David Lindsay joined forces with Piper aircraft President Lynn Helms, US Senator Strom Thurmond and others during the mid to late 1970s to continue to apply pressure on an A-10 program which by then was experiencing cost growth.<sup>77</sup> It did not seem to matter that the Enforcer would require significant development in order to make it suitable for the A-10 mission, and even then it would carry less payload and likely still be more vulnerable than the A-10. At one point “some members of Congress considered offering the Enforcer to the Army if the Air Force refused, but the Army backed away,

---

<sup>xxvii</sup> The Piper Enforcer, which had a strong resemblance to the WWII era P-51 Mustang, was designed and originally flown by David Lindsay, owner of Cavalier Aircraft. Lindsay sold the program to Piper Aircraft in 1970 but remained involved in the project after the closure of Cavalier in 1971. The original prototype Piper Enforcers were heavily modified P-51's with a single turboprop engine. The Enforcer was evaluated, but rejected, as a counterinsurgency aircraft by the Air Force in the early 1970s. Two later prototypes built in the 1980s were larger and had much less in common with the P-51.

apparently fearing another roles-and-missions fight.”<sup>78</sup> A flight test of the Enforcer was finally pushed on the Air Force in 1984, but the Air Force again concluded that it was not as good as the A-10, and by then A-10 production was ending.



**Figure 17. Pre-production and Prototype A-10s**

### **3.5.3 GAU-8/A Compatibility Testing**

Full scale development and integration of the GAU-8/A gun system with the A-10A was broken down into three parts.<sup>79</sup> Part I involved integrating the GAU-8/A prototype gun into the YA-10 and conducting ground and flight testing prior to a production decision. Part II included the full scale development of the GAU-8/A gun system and ammunition leading to ground qualification of pre-production systems. After development testing a Critical Design Review (CDR) would be conducted to determine what changes would be required for the production design to be compatible with the production A-10. Part III included support for the A-10 Development Test and Evaluation (DT&E) and Initial Operation Test and Evaluation (IOT&E). Part III would utilize pre-production gun systems in the A-10 DT&E aircraft.

Ground firings of the refurbished prototype guns in a highly instrumented nose section of a YA-10 were conducted in December 1973 and January 1974. No problems were reported, and subsequent ground tests of a second gun installed in a YA-10 at Edwards AFB, CA, also resulted in no problems. Flight testing with both YA-10s was conducted in February and March 1974, also at Edwards AFB. No major compatibility problems were noted, but a secondary gun gas ignition problem was noted. This caused a flame area in front of the aircraft, obstructing pilot vision and causing fluctuations in the engine pressure. Initial attempts to correct the problem by lengthening the gun barrels and using plastic bonded ammunition (as opposed to copper) failed to correct the problem (although the plastic bands were expected to extend the barrel life by cutting friction and corrosive blowby).<sup>80</sup> A double-baffled deflector was added but still failed to eliminate the engine perturbations. The final fix for the problem involved adding a potassium nitrate suppressant to the ammunition propellant. Follow-on tests with the new ammunition propellant mixture confirmed success in resolving the problem. Of note, the solution to the gun

gas ignition problem created a second problem; excessive residue from the gun firing covered the canopy and impaired vision.<sup>81</sup> The solution to this turned out to be far easier; a windshield washer was installed on the front of the canopy and was found to be operationally acceptable. Procedures for washing the engine with water were also developed as the residue (potassium bicarbonate) was found to be water soluble.

A second integration problem identified had to do with the gun pointing angle. Test pilots had reported that the gun angle was not right for low dive angle and low slant range strafing. Strafing at larger angles and slant ranges was satisfactory, but pilots were unable to concentrate bursts under low dive angle/low slant range employment. Flight tests conducted in June 1974 demonstrated that a 2 degree change in gun alignment would correct the problem. The gun alignment problem, with the proposed fix, was briefed at the DSARC IIIA<sup>xxviii</sup> review in July 1974. The fix for the alignment problem was implemented, and subsequent flight test indicated optimum gun alignment for the A-10 attack profile.

### 3.5.4 The Armor Piercing Round

An armor piercing round had always been considered one of the principle development challenges associated with the GAU-8/A. The armor piercing round with the steel core was proving to be ineffective against tank targets, and was eliminated from further development by the time of the full scale development awards. The second development approach being pursued against the tank challenge was the depleted uranium penetrator. The Air Force considered this a significant risk given the schedule for the A-10, so a tungsten carbide round was pursued as a backup. As a result of the June 1973 DSARC II review, GE was to take on two competitive subcontractors for ammunition development, with each of these subs developing target practice, high explosive incendiary, and armor piercing rounds, to include processes for manufacturing depleted uranium penetrators for the armor piercing rounds. Further, each of the subs was to obtain two supply sources for case, propellant and penetrator.<sup>82</sup> The cost of all this increased the estimated cost of ammunition development from \$9.2M to \$15M. As a further risk mitigation effort, the Air Force Armament Lab conducted a parallel full-scale development effort with contractors to provide high density penetrators, improved propellants, and alternative cartridge designs. Aggressive risk and cost reduction measures such as these (and others) reportedly allowed the program office to reduce the GAU-8/A round cost to \$15 each, representing an 80% reduction from the original cost estimate!<sup>83</sup>

Despite the Secretary of Defense approval in April 1972 for selected use of depleted uranium in munitions, concerns still lingered and a further study was requested by DDR&E in October 1973.<sup>xxix</sup> The objective of the study was “to foresee and be prepared to answer the many questions that may be raised within the DoD, the Public Health Service, Congress and the public with regard to DU use in munitions.”<sup>84</sup> In addition to consideration of combat use, the report considered “the environmental and medical considerations associated with manufacture, storage, use, and disposal of depleted uranium munitions.”<sup>85</sup> The report indicated no significant impact

---

<sup>xxviii</sup> DSARC IIIA was an OSD review in advance of limited production. DSARC IIIB reviews were conducted prior to a full rate production decision.

<sup>xxix</sup> The study addressed not only use of the DU round for the GAU-8/A gun system, but the Navy Phalanx and Army Bushmaster guns as well.

(environmental or medical) from normal use; however “Depending on conditions locally, significant impact can occur in the event of uncontrolled release of DU.”<sup>86</sup>

Manufacturing technology programs were initiated to reduce the cost and risk associated with the depleted uranium penetrator. A joint program between the Army and Air Force looked at machining them from bar stock using production equipment. The Battelle Institute examined casting and forging as lower cost fabrication techniques as well. The results of these investigations were shared with Aerojet and Honeywell, the two ammunition subcontractors. The Deputy Secretary of Defense approved Air Force use of the depleted uranium armor piercing rounds for testing following the DSARC IIIA review of the A-10 program in July 1974.



**Figure 18. A-10A Firing the GAU-8/A**

## **3.6 Production and Deployment**

### **3.6.1 Production Readiness Issues**

Fairchild Airplane Manufacturing Corporation was founded in 1926 in Farmingdale, New York. During World War II, it had many successful designs with the M-62 initial flight trainer being the most successful with over eight thousand being produced. The company had plants in Farmingdale, New York and Hagerstown, Maryland. Following World War II, they were successful with a series of large capacity troop carriers. By 1961, they had expanded into space applications and by 1964 had acquired Hiller Aircraft, a helicopter manufacturer. In 1965, the company took over Republic Aviation which had produced many bombers in World War II but had since been reduced to doing subcontract work.<sup>87</sup>

When the A-10 full scale development contract was awarded the company had been waiting while other work was drying up. Fairchild had not been running a full production line since the termination of the F-105, nine years earlier. This did not seem to be a concern to either

Fairchild or the Air Force at the time.<sup>88</sup> The Air Force conducted a customary pre-award survey of Fairchild's capacity, capability, and financial condition, and the company was rated as satisfactory. In fact, the company later proved itself to have many deficiencies which were to have long term consequences, and most of these were or should have been noted during the pre-award survey. Some historians have stated that the decision to pick Fairchild-Republic was based on which company could best stand a contract rejection.<sup>89</sup> Vincent Tizio, program manager at time of the fly-off, admitted that the cost factor dictated much of what they were doing – “we made many, many trade-offs studies on cost, maintainability, and performance.”<sup>90</sup> Republic did take the program very seriously. They set up a screened off “Tiger Works” to create a facsimile of Lockheed's “Skunk Works”. However, there had not been any capital investment in the plant. When the Air Force finally took a hard look they became concerned and, in 1973, sent a team to investigate both the Farmingdale NY and Hagerstown MD facilities. The team concluded that although Fairchild might have the competence to perform the research, development, test, and evaluation program, they lacked the capability to perform the production phase. A second report, seven months later, indicated that although some progress had been made, there was a refusal on the part of Fairchild to provide information about a proposed consolidation of the Farmington and Hagerstown plants. Serious doubts were growing about Fairchild's ability to meet the contract.<sup>91</sup>

### **3.6.2 Hails Report and Recommendations**

Tactical Air Command Vice Commander, Lieutenant General Robert Hails, was appointed to head a committee of experienced civilian and military professionals to review the program. No one on the committee had prior experience with the A-10 to ensure impartiality. Their findings were released on September 30, 1974 and were very critical of Fairchild from the experience and competence of the employees, outdated plant, to the structure and experience of top management. Some of the findings of the report are as follows:<sup>92</sup>

- The top level management of Fairchild was market-oriented and neither experienced nor structured to manufacture the A-10. In particular, it was noted that the A-10 program director had no direct control over either the Farmingdale or Hagerstown production facilities;
- The integration of the two production facilities was dependent on the company president that resided at neither of the facilities.

The SPO, the Air Force Plant Representative Office (AFPRO), and the Air Force Contract Management Division (AFCMD) were also cited for their lack of coordination, which was deemed to have affected Fairchild's responsiveness. Financial problems were also uncovered which projected a \$12M overrun, and schedule problems associated with the first six aircraft were occurring due to late receipt of key components from Fairchild's vendors.

The committee made a number of recommendations to both the SPO and Fairchild, including replacing a number of top managers at Fairchild.<sup>93</sup> Fairchild made other changes, to include establishing executive vice president control of all technical and production aspects of the A-10, and placing the Hagerstown plant under the authority of Farmingdale. Fairchild also undertook major capital investment, “replacing its overaged machinery and increasing its make/buy ratio for major machined parts for the A-10 from 23:77 to about 55:34.”<sup>94</sup> Some of the

cost of the investment was financed via the Defense Industrial Plant Equipment Center, with the rest coming from company funds. On the Air Force side, additional manpower was approved for both the SPO and the AFPRO, and the Deputy Chief of Staff for Systems at AFSC was established as the focal point for reporting and coordination between the SPO and the AFPRO.

One recommendation of the Hails report was that additional production capacity for the A-10 be established. This became infeasible at the Farmingdale plant as the new machining capability reduced the amount of space available for assembly.<sup>95</sup> Originally the plan had been for 90 percent of the production to be in Farmingdale, but in one of his last acts the outgoing president of Fairchild, Charles Collis<sup>xxx</sup>, suggested that between 20 and 41 per cent of the production should be reassigned to Hagerstown. The reasons stated for the reassignment of production were the avoidance of additional capitalization that would be required at Farmingdale, the lower labor rates at Hagerstown, and lower overhead rates due to lower property taxes at Hagerstown. While the reasons may have been valid, they did not satisfy New York congressmen who were concerned about the possible loss of 1,000 jobs from the state. The recommendations were studied by the Air Force in January and February 1975, and in March the Air Force reported that it was “not adverse” to move some of the workload to Hagerstown.<sup>96</sup>



**Figure 19. A-10 Fuselage and Wing Production**

---

<sup>xxx</sup> Charles Collis was replaced as President of Fairchild-Republic Division in March 1975, in the wake of the top management shake up that occurred at the end of 1974.

### 3.6.3 DSARC Reviews and Production Decisions

On 9 July 1974 the DSARC met to assess plans for low rate production of the A-10 aircraft, the GAU-8/A gun and 30 mm ammunition. Excellent progress had been made with respect to the design and test, but concerns regarding achievement of design-to-cost goals remained. At that time Fairchild was predicting a \$24.3M overrun, with \$17M of that to be passed to the Government. The SPO estimate at this time for the unit flyaway cost was \$1.6M (FY70\$, 600 aircraft buy), but both the OSD CAIG and an independent Air Force cost estimate came in at \$1.7M. Part of the reason for the increase from the \$1.5M goal was a 1,000 lb increase in the weight since the DSARC II review. The Air Force argued that the cost increase was within limits since the program was budgeted according to the \$1.7M per direction from the DSARC II decision. On 31 July 1974, Deputy Secretary of Defense Clemens authorized the Air Force to proceed with initial production using \$39M for long lead funding. The Air Force was given approval to procure 52 aircraft providing that “contract options to procure a smaller quantity (that is, 28 aircraft) be kept open”<sup>97</sup> pending completion of remaining tests and the Critical Design Review (CDR) for the armor piercing round. The DSARC met again in November 1974 to review closure of these issues. By then the GAU-8/A deficiencies with regards to the gun depression angle and secondary gun gas ignition had been resolved, and engine qualification tests for the TF-34 were completed on 31 October 1974. The CDR for the armor piercing round had not been completed, but was scheduled to be completed by Aerojet in December 1974.<sup>xxxii</sup> Based on this review, the Air Force was authorized to proceed with FY75 and FY76 production of 52 aircraft. The FY75 purchase of 30 mm ammunition was authorized pending successful completion of the CDR for the armor piercing round.

A two month delay in the first flight of the DT&E aircraft caused a subsequent delay in the DSARC IIIB review from October 1975 to February 1976. Required tests prior to the full-rate production decision included:<sup>98</sup>

- Freedom from flutter
- Initial performance measurements
- Flying qualities
- GAU-8/A-10 accuracy
- Ammunition performance (vs. tanks, trucks and APC's<sup>xxxii</sup>)
- Bombing accuracy
- Laser spot seeker (PAVE PENNY<sup>xxxiii</sup>) integration
- Aerial refueling
- IOT&E.

By the end of 1975, the one remaining issue was fatigue testing. The aircraft undergoing fatigue testing developed cracks on the fuselage frame at about 80 per cent of the desired 6,000 hour mark. A reinforcement corrected the problem, and the 6,000 hour objective was achieved on 28 October 1975. The reinforcement was to be retrofitted to several existing and pre-production

---

<sup>xxxii</sup> Aerojet completed the CDR for the armor piercing round in December 1974. Honeywell, the second ammunition subcontractor, would not complete its CDR for the armor piercing round until October 1975.

<sup>xxxiii</sup> APC: Armored Personnel Carrier

<sup>xxxiii</sup> PAVE PENNY is a target acquisition aid for guiding the pilot towards targets designated from the ground using a laser target designator.

aircraft, and the amended production process was to be in place by mid-1976 to support aircraft #14 and beyond.<sup>99</sup> With this issue resolved, Deputy Secretary of Defense Clements authorized full-rate production at a maximum rate of 15 aircraft per month. This was a reduction from the Air Force's proposed rate of 20 per month based on the assessments of the contractor's ability to finance and produce efficiently.<sup>100</sup> On 30 March 1976 the Commander of the Tactical Air Command accepted the first production A-10 from the Commander of Air Force Systems Command.

Full rate production approval for the GAU-8/A gun system and ammunition was given in March 1976. Under the approved program, the dual source subcontract arrangement for ammunition would continue through FY77. As the only source having completed qualification testing by then, Aerojet would remain the sole source for FY75 production, and a 60/40 split to Aerojet/Honeywell would be used for FY76 and FY77 production. The subcontractor arrangement for ammunition (with GE as the prime) would continue until FY78. Beginning in FY78 the Air Force would buy ammunition directly using competitive contracts with the two suppliers.

#### **3.6.4 Variant Considerations and Production End**

As the threat focus changed to the European Battlefield some of the earlier considerations were being looked at again. The lack of "relaxed stability" in prolonged manual flying was putting a strain on pilots. An inertial navigation system, weapons delivery computer, built-in drag chute, upgraded avionics and Heads-Up Display (HUD) were added. A two seat variant, the YA-10B, was developed by Fairchild for Night/Adverse Weather (N/AW) and use as a trainer. Proposed changes for the N/AW variant, in addition to the two-place cockpit, included ground mapping radar, a Forward Looking Infrared (FLIR) pod, and larger vertical stabilizers. The only YA-10B actually built was a modified pre-production A-10A (see Figure 20). While the Air Force flight tested the YA-10B in 1979, they chose not to pursue further development of the two seat variant. In the 1980s the OA-10 Observation and Reconnaissance conversion was introduced. The alterations necessary were relatively minor and inexpensive to implement. These were mostly internal although there was modification in the pylon loading to allow phosphorus marker rockets to replace the Mavericks and bombs.





**Figure 20. Flight Testing the YA-10B**

In 1982 Congress voted to discontinue all funding to the A-10 with the Fiscal 1983 Defense Authorization Bill, and line termination costs of \$29 million were provided. By this time the F-16 was the “darling” of the Air Force, and there were few proponents within the service for continued production of the A-10. Fairchild lobbied Congress in an attempt to get the decision reversed. The Reagan administration had sought funds for thirty A-10s in 1983 and an additional twenty in 1984 but was not successful. Fairchild had planned on selling seventy plus A-10s to foreign countries but was unable to do so. The final aircraft (No. 713 s/n 82-0665) rolled off the line in March of 1984 and ended eleven years of production. This was the last plane to be built in the Hagerstown, MD plant. Fairchild did get the contract for the T-46A trainer but when the first presentation of the aircraft was made in 1985 it turned out to be not much more than a hollow shell. Although the later flight test revealed a good aircraft, the company had sacrificed a lot to get to that point and was in serious financial trouble. Costs of the T-46A program were escalating and the program was cancelled in 1987. Fairchild entered talks with Grumman and Boeing to sell off the aircraft division, and did end up selling the rights to the A-10 program to Grumman in 1987. After 60 years of business the Hagerstown plant was shut down, and Fairchild ceased to continue as an aircraft company.<sup>101</sup>

### **3.7 Retirement Plans, Operations, Sustainment ... and Life Extension**

#### **3.7.1 The Continuing Debate over the CAS Aircraft**

By the time A-10 production ended in the early 1980s, several developments began to rekindle the debate over the optimum CAS aircraft. The F-16 aircraft was proving its mettle both in training with the US and in actual combat with the Israeli Air Force. In particular, its successful use by the Israelis in both ground attack (the 1981 attack on the Iraqi nuclear power plant) and in air-to-air combat (the 1982 Bekaa valley campaign) re-energized proponents for fast multi-role fighters. Further, the F-16 was relatively low cost compared to the other new fighters of the era such as the F-15 and the Navy F-14. The second development which fueled

the debate was the Army's unveiling of its AirLand Battle Doctrine in 1982. The AirLand Battle envisioned a much faster and free flowing battle without a traditional battle line. The Army intended to use both firepower and maneuverability to slow the Soviet advance and simultaneously attack their reserve troops before they could be used to engage friendly forces, forcing the attacking troops to either retreat or surrender. This put a much greater emphasis on Battlefield Air Interdiction (BAI), which favored a faster aircraft and required less reliance on direct coordination with ground troops. Also in this timeframe, the Army had been given approval to begin production of the AH-64 Apache helicopter, the successor to the failed AH-56 Cheyenne program. While the AH-64 was less ambitious than the AH-56, it was to provide the Army with the organic close support fire they had long sought. All of these developments caused leaders in the Air Force to question whether or not the A-10 was the CAS aircraft needed for the future.

By 1985 the Air Force completed the first of several studies which suggested that a modified variant of the F-16, labeled the A-16, would be a good choice for a CAS aircraft to support the AirLand Battle. Other authors have written that the idea for the A-16 actually originated about the time that the Army unveiled the AirLand Battle doctrine.<sup>102</sup> The 1985 report stated that it expected the A-10 would lose its effectiveness in mid to high intensity conflicts by the mid 1990s. Specific concerns were survivability against new Surface-to-Air Missiles, the ability to perform air interdiction, and the ability to operate in night and adverse weather.<sup>xxxiv</sup> A modification of an existing aircraft that could be fielded in the mid 1990s was considered necessary to avoid competition with the top new fighter development priority; the Advanced Tactical Fighter (precursor program for the F-22). The 1985 report was followed in December 1986 with an Air Force recommendation to OSD to replace the A-10 with the A-16.

While Air Force leaders were certainly behind the A-16 concept, others were less anxious. OSD was critical of the Air Force proposal for not giving full consideration to other candidate aircraft, and disapproved the Air Force recommendation.<sup>xxxv</sup> An Air Force Scientific Advisory Board (SAB) report also raised concerns, concluding that CAS and BAI missions are sufficiently different for each to warrant a separate aircraft. The SAB recommended pursuing a new specialized CAS aircraft for the future, while modifying the A-10 with advanced avionics and more powerful engines for the short term. OSD directed the Air Force to perform a Close Air Support Aircraft Design Alternative (CASDA) study, and created the Close Air Support Mission Area Review Group (CASMARG) to ensure the Air Force considered other alternatives besides the A-16. In December 1987, the Air Force issued a request for concept proposals and received proposals from 9 manufacturers, including Fairchild Republic. Fairchild was not awarded a study contract due, in part, to their recent problems executing the T-46 program. OSD remained skeptical of the program, and Congress raised questions as well, requesting a GAO study on the status of the Air Force's efforts to replace the A-10.<sup>103</sup> The GAO report noted that the intended start of the A-10 replacement, 1993, occurred earlier than the service or structural life required. The Air Force had already started converting A-10s to OA-10 Forward

---

<sup>xxxiv</sup> Of note, the Air Force had rejected the Night/Adverse Weather variant of the A-10 just a few years earlier, and would continue to rate the A-16 with advanced night and adverse weather avionics more favorably than the A-10 for which few were interested in considering the same avionics upgrades. A later proposal also added a 30 mm gun pod to the F-16 to provide "tank-busting" capability.

<sup>xxxv</sup> The OSD did approve the development and testing of two modified A-7 prototypes for the CAS mission.

Air Controller (FAC) use, but the amount and rate at which the conversion would occur was dependent upon the A-10 replacement effort. The OSD appointed CASMARG did not concur with the requirement for a mid 1990s date for A-10 replacement, and this was noted in the GAO study. Despite the many misgivings on the Air Force replacement plans, the GAO report made no recommendation, and the CAS replacement aircraft debate went on.

The National Defense Authorization Act for FY88-89 directed the Secretary of Defense to provide a CAS/BAI master plan by the end of 1989. Later amendments associated with base realignment and closures furthered directed examination of transferring the A-10 and the CAS mission to the Army. To resolve which aircraft was best suited to perform the mission in the future, it directed that OSD's OT&E directorate plan a competitive flyoff between candidate aircraft.<sup>104</sup> Hearings and studies continued through 1989, and the planned flyoff added more and more aircraft (A-10, F-16, A-7, AV-8, F/A-18) and extended the time over which it would occur (6 years in duration, starting in 1995). The Air Force continued to push for the A-16, so OSD called for a Defense Acquisition Board (DAB)<sup>xxxvi</sup> which was to make an acquisition decision by April 1990. The DAB decision was pushed back to the fall of 1990, but by then there were two other world developments that began to influence the debate. First, the fall of 1989 saw the beginning of the breakup of the Warsaw Pact in Eastern Europe, with German reunification occurring in October 1990. Second, on 2 August 1990, Iraq invaded Kuwait, and three days later President Bush initiated Operation Desert Shield by sending US troops to the Middle East to prevent further advance of Iraqi troops into Saudi Arabia. When the DAB finally made its decision in fall 1990, it was a compromise. The Air Force would retain two wings of A-10s, and it would retrofit up to four wings of F-16's to perform the CAS and BAI missions.

### **3.7.2 Desert Storm and Post War Assessments**

By almost all accounts, the A-10, its pilots, and its ground crews performed very well in Desert Shield and the second phase of the war, Desert Storm. In addition to flying CAS missions, it conducted BAI missions in Kuwait and Southern Iraq, combat air patrols looking for SCUD mobile missile launchers, armed reconnaissance, and armed escort for search and rescue missions. Despite a lack of avionics for night missions, A-10 pilots adapted by using the display from their infrared Maverick missiles. The GAO reported that the A-10 had the highest sortie rate, with an average of 1.4 sorties per aircraft per day, and delivered more guided munitions (almost 5,000 Maverick missiles) than any other aircraft type.<sup>105</sup> The GAO report also indicated that the number of A-10 sorties was likely undercounted, indicating an even higher achieved sortie rate was likely. While the gun was considered effective, the number of gun "kills" was unclear due to conservative rules for performing Bomb Damage Assessment during and after the war. An Iraqi regimental commander described the A-10 as "the single most recognizable and feared aircraft", noting its ability to conduct multiple raids per day, loiter around the battlefield, and attack with deadly accuracy.<sup>106</sup> The A-10 survivability was also generally confirmed: "... the Hog's redundant flight control system allowed crippled planes to fly home. Aircraft Battle Damage Repair (ABDR) crews repaired in-theater all but one of the estimated seventy damaged A-10s during this war – and of those, twenty suffered significant damage. These repairs were usually quick, and used cheap, accessible materials."<sup>107</sup> (See Figures 21, 22.)

---

<sup>xxxvi</sup> The DAB was the successor to the DSARC.

Notably, twenty four F-16A/B aircraft of the 174<sup>th</sup> Tactical Fighter Wing were converted to a CAS configuration prior to deployment in Desert Storm. They carried a pod-mounted GAU-13/A four barrel derivative of the GAU-8/A, with 353 rounds of 30 mm ammunition and a PAVE PENNY laser target acquisition system. The “CAS” F-16’s did not perform well in Desert Storm. The pylon mounted gun was not as steady as the A-10’s rigid mounting, resulting in shaking of the aircraft which made it hard to control the round placement. The higher speed of the F-16 also did not provide enough time when approaching a target for gun engagements. After several days of operations the gun pods were removed, and the “CAS” F-16’s went back to more standard F-16 operations. While F-16’s in general performed well in Desert Storm, this effectively ended plans for the A-16 variants.

Post Desert Storm, the CAS roles and missions debate lived on. Air Force Chief of Staff General Merrill McPeak favored giving the CAS mission (and the A-10) to the Army, but he wanted the Army to give up the deep strike missions with the Army Tactical Missile System (ATACMS). He was outvoted by the other service chiefs and his sweeping recommendations for roles and missions realignment would not be implemented.<sup>xxxvii</sup> The Air Force made a decision to keep the A-10 in the active duty force, albeit in smaller numbers due to an overall reduction in combat wings in the Air Force. Beginning in 1991, 183 A-10s produced from production orders prior to FY78 were placed in long term storage at Davis Monthan AFB, and several others were retired to museums or converted to battle damage repair or maintenance trainers. Attention now shifted to how the remaining A-10s would be sustained throughout their renewed service life.

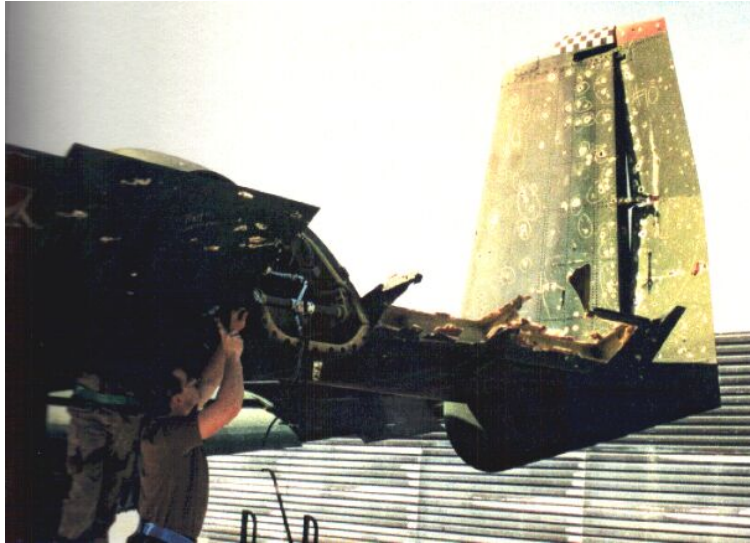

**Figure 21. One of the Six A-10s Lost in Desert Storm.**

“Wheels up, hard stick landing. Everyone said it couldn't be done, including the Flight Manual's and Tech Orders... pilot Capt Rich Biley proved'm wrong on 22 Feb 1991! ... Capt Biley was unhurt during the crash.”<sup>108</sup>

---

<sup>xxxvii</sup> Part of what made General McPeak’s recommendations more difficult to accept by the other services were the wide ranging impacts they would have had. Beyond the changes in CAS and deep strike roles, he wanted the Army and the Navy out of the space and long range air defense business, and he recommended that the Marine turn their fixed wing F/A-18’s over to the Navy.



**Figure 22. Repaired Aircraft 80-186**

This Aircraft was damaged on three separate occasions during Desert Storm, the last one resulting in approximately 300 holes. The plane was repaired and continued to fly and fight.<sup>109</sup>

### **3.7.3 Structural Integrity Issues and HOG UP**

The Air Force initiated the Aircraft Structural Integrity Program (ASIP) in 1958. The intent was to monitor and evaluate the structural health of Air Force operated aircraft throughout their operational life, precluding structural failure of in-service aircraft attributable to fatigue.<sup>110</sup> The governing Air Force Instruction, AFI-63-1001, requires the Air Force to have a plan for monitoring and evaluating the structural health of each type of aircraft in the operational inventory. The general guidelines and technical details for the AFI are contained in MIL-HDBK-1530. During the 1970s and 1980s, the Air Force performed damage tolerance assessments and developed inspection and modification programs on every major aircraft system in order to maintain operational safety. As part of the ASIP, fatigue tests were performed on the full aircraft as well as components such as the wing and fuselage.

The A-10 was originally designed for 6,000 hours of use comprising a specified mix of operational weights, sortie types and maneuver loads. The original design spectrum was used for the initial full-scale fatigue testing performed from 1975-1977.<sup>111</sup> The original test to two lifetimes (12,000 hours) was completed successfully with repairs in 1976. Noting that other current aircraft were being designed for 8,000 hours service life, the fatigue test was continued with the intent of reaching two times the longer service life. In 1977, after 13,768 Effective Flight Hours (EFH), cracks were observed at Wing Station (WS) 23 where the wing is joined to the fuselage. The wing was repaired using extensive cold working of the lower wing center panel to improve the fatigue life. The test was to resume, but a new design load spectrum, referred to as Spectrum 3, was adopted based on a 3,000 hour Loads/Environment Spectra Survey (L/ESS). Spectrum 3, based on evidence of more severe fleet usage than originally predicted, was more severe than the original design spectrum. Wing testing resumed in 1979 under Spectrum 3, but was halted at 58% of Spectrum 3 service life due to several failures (and subsequent repairs) at both the left and right wing outer panels and finally the centerline WS 0.

There were several design changes that resulted from the full-scale fatigue testing using Spectrum 3. The thickness of the lower skin on the wing outer panels was increased, and cold working was performed at the location of the fatigue test crack initiation. The effectivity of this change was for production aircraft #442 and subsequent, but a tech order (TCTO-0952) was generated to inspect or reskin the lower wing outer panels of all previous production aircraft (production #'s 7-441). TCTO-0952 was rescinded in 1986 with approximately 200 aircraft not having received the modification. The wing center panel also underwent a redesign in order to withstand 8,000 hours of Spectrum 3 usage. The redesign consisted of increasing the lower skin panel thickness and modifying the lower spar caps to accommodate the thicker wing skins. The effectivity of the wing center panel redesign was production aircraft # 582 and subsequent. Due to the extent of the wing center panel modification, no retrofit to earlier aircraft was economically feasible. Cold working of the wing center panel at WS0 was also performed starting with production aircraft #530, and performed as a retrofit to earlier aircraft. These modifications resulted in several structural configurations as shown in Table 11.

A wing-only fatigue test was conducted on a configuration consisting of a cold worked wing center panel, a production left outer panel, and a retrofit right outer panel. This wing was successfully tested to 12,000 EFH of Spectrum 3 with repairs between 1980 and 1988. Having demonstrated two times the service life, the retrofit configuration wings were qualified for 6,000 hours of Spectrum 3 usage. The thick skin production wings were qualified for 8,000 hours. Fatigue testing of the forward fuselage and empennage was also conducted between 1980 and 1986, demonstrating 17,500 EFH of Spectrum 3 usage on the forward fuselage, and over 19,000 EFH of Spectrum 3 usage, with repairs, on the empennage.

**Table 11. A-10 Structural Configurations**

Retrofit WOP Configuration	Intended for Aircraft 7-441 (not completed on all aircraft)	Thin wing center panel, cold worked at WS 0, Retrofit thick wing outer panel. Qualified to 6,000 hours Spectrum 3.
Production WOP	Aircraft 442-581	Thin wing center panel, cold worked at WS 0, Production thick wing outer panel. Qualified to 6,000 hours Spectrum 3.
Thick Skin Configuration	Aircraft 582 and subsequent	Production increased wing center panel and outer panel thickness. Configuration qualified to 8,000 hour service life.

The initial Damage Tolerance Assessment (DTA) for the A-10 was done by Fairchild in 1980, and several re-assessments were done after that. After the 1992 decision to keep the A-10 in the inventory, Grumman Aerospace, who took over the A-10 program from Fairchild Republic in 1987, delivered an updated DTA. The DTA analyzed 52 control points in the wing, and comparison between the 1980 and 1993 DTAs indicated that service lives were reduced on 8 of these control points after the later assessment. The 1993 DTA and its associated Force Structural Maintenance Plan (FSMP) took into account the three different structural configurations for the A-10 (see Table 11). Of greatest concern for the wing was the fuselage attachment joint at WS 23 for the retrofit configurations (especially those that had not received the thick wing outer

panel retrofit prior to TCTO-0952 being rescinded). Figure 23 shows how the FSMP was intended to influence procedures for inspection, repairs and modifications. The -6 T.O. indicated in the figure refers to the Tech Order for Scheduled Inspections and Maintenance. Generally following the guidelines in MIL-STD-1530A, the 1993 maintenance plan established inspection intervals based on service life and safety limits, and was intended to be accomplished as programmed inspections on all aircraft.

The FSMP inspection requirements were not incorporated into the inspection and maintenance tech order (T.O. 1A-10A-6) and, therefore, not accomplished as intended.<sup>112xxxviii</sup> The A-10 program office, by then part of the Air Logistics Center at McClellan AFB, CA, chose to perform the inspections using sampling as opposed to monitoring all aircraft. The Analytical Condition Inspection (ACI) program contained some of the FSMP inspection locations, including the critical WS 23 location, but the inspections were conducted on relatively few aircraft as compared to the fleet wide inspections called out in the FSMP. There were several factors contributing to the breakdown in the FSMP implementation.<sup>113</sup> The A-10 did not utilize Programmed Depot Maintenance, so inspections would have to have been conducted in the field, and severe budget constraints were also cited. Sometime in the mid 1990s the flight data recorder system, used to sample the fleet wide usage, became unsupported and no longer yielded accurate data. Even more disruptive was a Base Realignment and Closure (BRAC) decision in 1995 to close McClellan AFB and move the maintenance and repair operations to Hill AFB, UT. By the time the BRAC decision was fully implemented in 2000, the SPO had lost 80% of its experienced workforce. Similar turnover was noted at the System Program Director and Chief Engineer level. Grumman, which merged with Northrop in 1994 to form Northrop Grumman Corp., continued as the prime contractor for the A-10, but most modifications during this time were competed or done organically. “Fallout funds were used to task NG to incorporate design changes into the configuration baseline drawings and perform system level analysis.”<sup>114</sup> In 1997, the SPO competed the prime contract and subsequently awarded Lockheed Martin Systems Integration (LMSI), formerly IBM Federal Systems Division in Owego, NY, an Indefinite Delivery/Indefinite Quantity (ID/IQ) contract to take over as the new prime for A-10. It should be noted that LMSI was not an aircraft company and did not have the aircraft infrastructure available at Lockheed Martin’s Fort Worth, TX or Marietta, GA locations. At the time, the SPO expected that Northrop Grumman would be part of the prime team since Lockheed Martin and Northrop Grumman had proposed a merger in July of 1997. In March of 1998 the US Department of Justice moved to block the merger in federal district court, and the merger was subsequently called off in July of 1998. As a result, Northrop-Grumman was diminished to a supporting role, and became further marginalized by Lockheed Martin’s use of Southwest Research Institute to provide structural analysis as part of the prime contract team. For the next six years, “the prime team consisted of organizations that had no direct experience or infrastructure developing, building, and supporting an entire aircraft.”<sup>115</sup> In late 2004, the Air Force “requested” that LMSI include Northrop Grumman as a member of the prime team, but Northrop’s participation would be limited to specific structures work for several more years.

---

<sup>xxxviii</sup> An Air Force Materiel Command Red Team in 2003 (see associated endnote) indicated “a systemic neglect of the A-10 weapon system after the initial retirement started in 1988”.

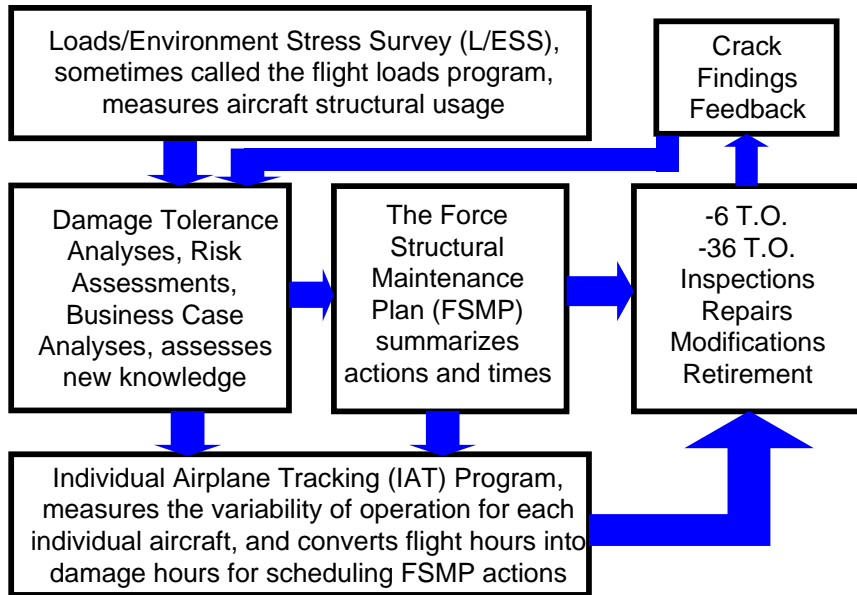

**Figure 23. FSMP Establishes Required Maintenance Actions<sup>116</sup>**

The Analytical Condition Inspections conducted in 1995-96 discovered cracks in several wing locations due to fatigue. Most of the cracks were consistent with the DTA crack growth curves updated in 1993, but two cracks at WS 23 were clearly under predicted by the low Initial Flaw Size (IFS) curve, and one of the cracks was of “near-critical” size (see Figure 24). For reasons not determined by the Red Team Investigation in 2003, the SPO classified the cracks as minor and did not reconsider their implementation of the FSMP.<sup>117</sup> Suspected reasons for the classification decision include avoidance of the disruption and burden associated with field inspections by operational units.

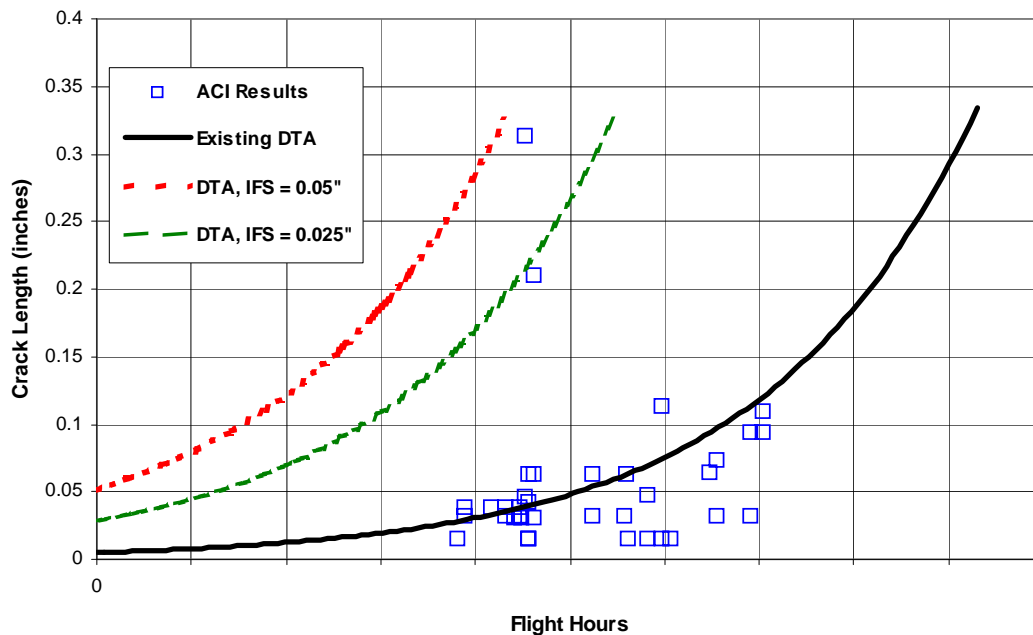

**Figure 24. WS 23 - DTA versus ACI Findings<sup>118</sup>**



In 1998 Northrop Grumman was tasked to provide a cost effective structural enhancement program focusing on the most critical areas.<sup>119</sup> In August 1998, they delivered a report entitled “A-10A Aircraft Wing Center Panel Rework-Fatigue Life Improvement”. The plan detailed structural changes required to support a 16,000 hour service life. The report recommended immediate implementation, and verification using a full-scale fatigue test on a modified wing. This report formed the basis of the subsequent HOG UP program to extend the structural life to the year 2028, but the report was based on the assumption that the 1993 FSMP had been implemented. Further, the report did not consider the impact of ACI crack data or new fatigue sensitive locations that had been identified by field inspections. The SPO initiated the HOG UP program in 1999 as a repair program instead of a modification despite the fact that the majority of the parts for the repair were to be kitted, and the same configuration was to be applied to all thin-skinned wings.<sup>120</sup> Managing HOG UP as a repair did not require acquisition approval, and maintenance funding could be used. Since it was a “repair”, the SPO held that Configuration Control Board (CCB) action was not required, and “appropriate configuration control concerns, such as technical analysis of service life, technical contents of the program, and method to evaluate an organic or contractor prepared engineering change proposal did not occur.”<sup>121</sup>

The HOG UP program expanded from its initial beginnings. At the request of Air Combat Command, center wing fuel bladder replacement, rework of the flight control system, nacelle fitting inspections, and other areas were added to HOG UP. Figure 25 shows a comparison of the 1999 and 2003 program. All modifications were considered worthwhile, but the Red Team investigating the program in 2003 noted no composite estimate of the risk of structural failure had been generated and expressed concern that the repair might not result in the intended life extension.<sup>122</sup> A further complicating factor had to do with the problematic cracks at WS 23. In 2001 the WS 23 crack was reclassified as critical, and a new tech order (TCTO 1438) was issued for inspection of the wing center panel and WS 23 fastener holes. Estimates in 2003 were that 35 aircraft would require refurbished wings associated with the WS 23 repair. Although not originally part of HOG UP, the WS 23 inspection and repair was subsequently scheduled to be conducted concurrently with the expanded HOG UP repairs.<sup>xxxix</sup> This touched off a series of problems due, in part, to longer than expected time to produce HOG UP wings, and higher number of unusable wings found as a result of the WS 23 inspection (they found 27 bad wings they had not expected). By the time the Red Team investigated the HOG UP program, it had grown from approximately \$140M to over \$600M, not including unprogrammed costs associated with the WS 23 wing refurbishment and associated remove and replace process. Further, the full-scale fatigue test<sup>xi</sup> to validate the HOG UP repair had not yet been done, leaving the Red Team to conclude that the actual structural condition of the fleet remained unknown, and the repair was “un-validated for extending the lives of A-10 wings to 2028 (~16,000 Hours).”<sup>123</sup> Several alternative approaches were offered by the Red Team, including the replacement of high-time production center wings with previously considered inviolate wings<sup>xli</sup> or newly manufactured thick wing versions of the center wing.

---

<sup>xxxix</sup> Both programs were essentially combined, and are often referred to as Service Life Extension Program (SLEP1).

<sup>xi</sup> The fatigue-test was to be conducted over a three year time period, simulating 10 years of operational use.

<sup>xli</sup> Wings classified as inviolate were “thin” wings with generally low service life in storage at Davis Monthan AFB.

# Hog Up 1999 and 2003

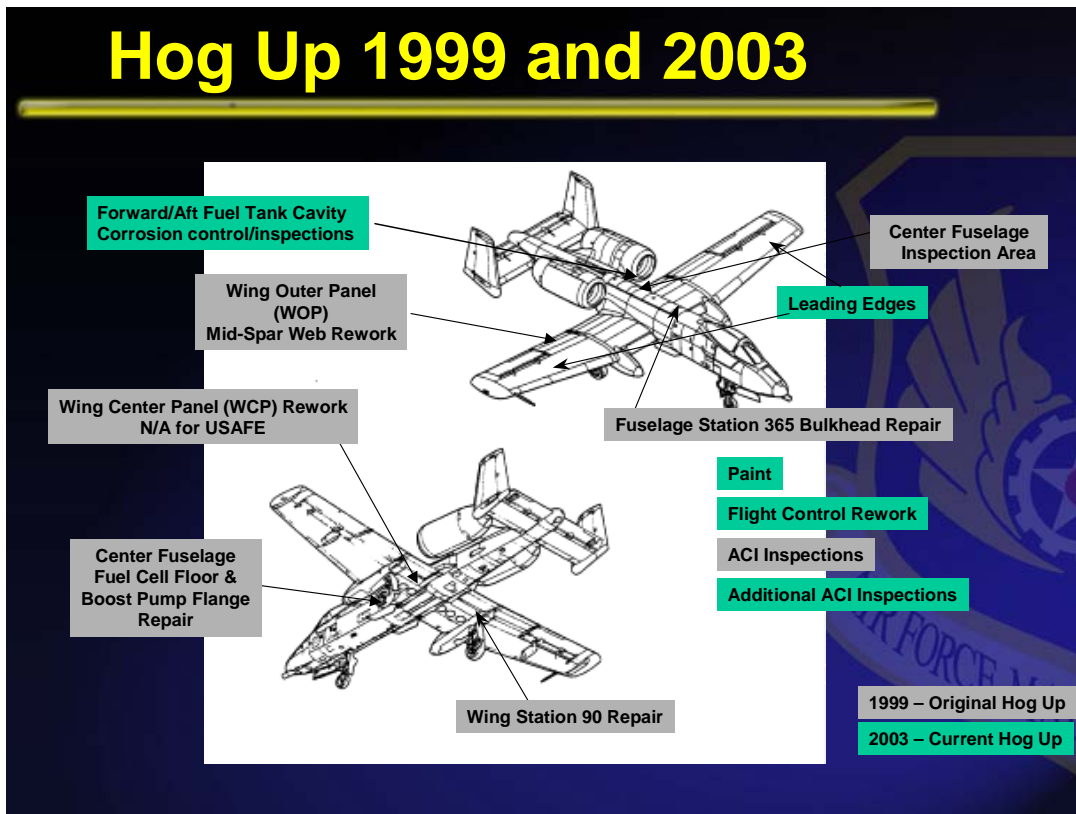

Figure 25. Comparison of 1999 and 2003 HOG UP Program<sup>124</sup>

Subsequent to the Red Team report in February 2003, the wing undergoing full-scale fatigue testing failed short of the 16,000 hour life expectancy.<sup>125</sup> In addition, thin-skin wings coming into the depot were failing inspection at an increasingly higher rate, and it became clear that the Air Force would run out of serviceable wings by about 2011.<sup>126</sup> By 2005 the failure rate of the thin center panel wings coming in for service life extension was averaging close to 30%. In 2005 the AF completed a business case analysis which considered three options for structural life extension.<sup>127</sup> Option 1 consisted of organic sustainment of the thin skin wings. It entailed salvaging and rebuilding WS 23 failures to eliminate shortfalls, and increasing the SLEP1 to extend the service life. The estimated Life Cycle Cost (LCC) for Option 1 was \$4.6B. Option 2 entailed purchasing 135 wings to replace the WS 23 failures, and increasing SLEP1 for the remaining wings. The LCC for Option 2 was \$3.16B. Option 3 was to buy 242 wings to replace WS 23 failures and avoid the high cost of adding to the SLEP1. The estimated LCC of Option 3 was \$1.72B. A decision was made to pursue Option 3 based on clear cost avoidance associated with that option. In early 2006, the Air Force prepared a budget justification for production of newly manufactured “thick skin” wings to re-wing the remaining “thin skin” A-10s in the inventory.<sup>128</sup> The budget estimate was \$741M for replacing up to 121 wings, with the intention that 242 wings would be replaced between 2012 and 2018. Also in the budget justification was approximately \$5M to build a computer model capturing the most current configuration of the A-10 wing assembly to support future sustainment operations. This became necessary, in part, to duplicate the as-built configuration as opposed to the as-designed. This also allowed the SPO to compete the contract for new wings, an important consideration due to the absence of an Original

Equipment Manufacturer (OEM). In the end, Aerospace Engineering Spectrum LLC would be awarded the contract to build a computer model for a wing that would be manufactured by Boeing (the winner of the new wing contract in 2007). The wing would be installed on an aircraft built by Fairchild Republic, for which Lockheed Martin was now the prime.<sup>xlii</sup> This was the new reality of sustainment for the A-10.

#### **3.7.4 A Second Life for a Modern Day Hog**

Prior to, and coincident with the HOG UP program, several other upgrade programs were addressing other aspects of the A-10 weapon system. In the early 1990s, the aircraft was modified to incorporate the Low Altitude Safety and Targeting Enhancements (LASTE) system. This system added ground collision avoidance warnings, an Enhanced Attitude Control (EAC) function for aircraft stabilization during gunfire, a low altitude autopilot system, and computed weapon delivery solutions for targeting improvements. The LASTE system also added an Operational Flight Program (OFP) to provide the computer control software necessary to perform the above functions. Starting in 1999, the A-10 was upgraded with the installation of an Embedded Global Positioning System/Inertial Navigation System (EGI). The EGI system provides improved navigation and situational awareness. Perhaps the most significant upgrade was the Precision Engagement (PE) program awarded to Lockheed Martin in 2005. This program, which results in the modified aircraft being redesignated as A-10Cs (see Figure 26), includes enhanced precision target engagement capabilities. The A-10Cs are able to carry the INS/GPS guided Joint Direct Attack Munitions (JDAM) and the Wind Corrected Munitions Dispenser (WCMD). Other modifications in the PE upgrade include hands-on throttle and stick control, new multi-function cockpit displays, situational awareness data links, digital stores management, integrated flight and fire control computer, LITENING II and Sniper laser targeting pod carriage, and a new armament HUD control panel. Flight testing of an A-10C prototype began in 2005, and as of January 2008 the 100<sup>th</sup> A-10C conversion had been delivered.<sup>129</sup> The PE upgrade is intended to evolve the A-10 from its origins as a cold-war tank killer, to an aircraft capable of performing a wide range of operations to support the Global War on Terror and other contingencies. As of the date for this case study (2008), programs for replacement of the TF-34 engine with a higher thrust model have been formulated but not yet funded. With the combination of the PE upgrade and the re-winging of the thin skin production aircraft, the Air Force has committed itself to sustaining the A-10 for the foreseeable future.

---

<sup>xlii</sup> At the request of the government, Northrop Grumman became part of the prime team with Lockheed Martin in 2005.



**Figure 26. A Newly Modified A-10C**

## 4 Summary

The A-10 aircraft had an inauspicious beginning for an Air Force that many have suggested only wanted the aircraft to keep the Army from taking over the CAS mission. The Air Force always believed that a fast multi-role fighter was a better choice for the feared war in Europe, but agreed to procure the A-10 for contingencies and “limited wars” like Vietnam. For its part, the Army seemed to like the A-10 as long as it did not threaten its own development of attack helicopters, and on several occasions the A-10 did pose a political threat to continued funding for those helicopters. Despite these challenges, the Air Force did embrace development of the A-10 and produced a specialized CAS aircraft that would prove effective in a variety of operations throughout the world (fortunately for mankind in the 20<sup>th</sup> century, a shooting war between NATO and the Warsaw Pact never erupted, and it never became necessary to prove the A-10’s mettle against the armies and air forces of Eastern Europe). Close attention to key mission characteristics (lethality, survivability, responsiveness, and simplicity) allowed the concept formulation and subsequent system design to result in an effective CAS aircraft, and design-to-cost goals kept the government and contractor focused on meeting the critical requirements at an affordable cost. The A-10 did not meet all its cost goals, but it came much closer to them than most major defense development programs did in that time frame or since then.

There were many aspects of the A-10 program that were unique for its day. It was a design-to-cost program when most other aircraft programs were clearly putting performance first. It was the first major defense program to embrace the newly favorable competitive prototyping approach to allow a source selection decision to be made on the basis of demonstrated performance and maturity of the design. It may be the only aircraft program ever designed around the armament (the GAU-8/A gun system), and it was unique in how it managed the development of the gun and its associated ammunition as part of the overall A-10 program. Both the A-10 and its gun were forced to prove themselves in multiple comparative “fly-offs”, and even more “fly-offs” were threatened but never materialized. While not unique to the A-10, it should be noted that many of the same political challenges that accompanied the inception of the A-10 never went away and continue to challenge the A-10’s existence today.

Alas, no program is perfect, and the A-10 provides no exceptions to that observation. Overlooked problems associated with production readiness and contractor financial stability did not go away and had to be resolved far too late in the development program. More significantly, the original structural design proved inadequate for the design life, and even fixes during production were inadequate for all but the latest aircraft produced. This problem was compounded by loss of the Original Equipment Manufacturer (OEM), on-again/off-again decisions to retire the A-10, unstable funding for inspection and repair, and major personnel disruptions resulting from a BRAC decision. Critical “health of the fleet” structural inspections were not performed during sustainment, and a subsequent repair program failed to provide the desired level of life extension. Despite these problems, the A-10, with precision engagement upgrades and new wings in production, appears to be back on track for a life extension that will double its service life and keep it flying until 2028.



## 5 References

- <sup>1</sup> Ferrara, Joe, "DOD's 5000 Documents: Evolution and Change in Defense Acquisition Policy" *Acquisition Review Quarterly*, Fall 1996, pp109-130.
- <sup>2</sup> Department of Defense Directive 5000.1, Subj: Acquisition of Major Defense Systems, DDR&E, 13 July 1971.
- <sup>3</sup> DoD Architecture Framework, Version 1.5, 23 April 2007.
- <sup>4</sup> Friedman, George and Sage, Andrew, *Case Studies of Systems Engineering and Management*, INCOSE Systems Engineering Journal.
- <sup>5</sup> A-10/OA-10 Fact Sheet, Air Force Link, <http://www.af.mil/factsheets/factsheet.asp?id=70>.
- <sup>6</sup> Campbell, Douglas, N. *The Warthog and the Close Air Support Debate*, Naval Institute Press, Annapolis, 2003, pp 177-178.
- <sup>7</sup> Smith, Peter, C., *Fairchild-Republic A-10 Thunderbolt II*, The Crowood Press, Berkshire, UK, 2000.
- <sup>8</sup> Campbell, Douglas, N. *The Warthog and the Close Air Support Debate*, Naval Institute Press, Annapolis, 2003.
- <sup>9</sup> *Ibid.*, p 51.
- <sup>10</sup> *Ibid.*, p 50.
- <sup>11</sup> *Ibid.*, p 51.
- <sup>12</sup> Pike, O., *et al.*, "Report of Special Subcommittee on Tactical Air Support [No. 44]", January 1966.
- <sup>13</sup> *Ibid.*, pp 1-68.
- <sup>14</sup> Report, U.S. Congress, House, *Close Air Support*, 89<sup>th</sup> Congress, 1 February 1966.
- <sup>15</sup> Campbell, Douglas, N. *The Warthog and the Close Air Support Debate*, Naval Institute Press, Annapolis, 2003, p 62.
- <sup>16</sup> Ltr, Gen John P. McConnell, CSAF, USAF (AFCCS), to Secretary of the Air Force, subj: HQ USAF Study on "Force Options for Tactical Air", 16 Mar 65.
- <sup>17</sup> RAND Report (C/GDS-83), Goldberg and Smith, "The Close Support Issue (U)", p 33.
- <sup>18</sup> RAND Report (R-906-PR), Goldberg and Smith, "Army-Air Force Relations: The Close Air Support Issue (U)", October 1971, p 33.
- <sup>19</sup> AF Form 71, Requirements Action Directive RAD 7-69 (1), "Requirements for a Specialized Close Air Support Aircraft (A-X), 22 Dec 1966.
- <sup>20</sup> *Ibid.*, p 7.
- <sup>21</sup> *Ibid.*, p 1.
- <sup>22</sup> AFRDQ (Directorate of Operational Requirements and Development Plans, Deputy Chief of Staff/Research and Development) A-X Proposal, Deputy for Studies and Analyses, Systems Engineering Group, WPAFB, OH, 19 April 1967.
- <sup>23</sup> *Ibid.*, p 5.
- <sup>24</sup> *Ibid.*, p 80.
- <sup>25</sup> *Ibid.*, p 81.
- <sup>26</sup> *Ibid.*, p 5.
- <sup>27</sup> Requirements Action Directive: Air-to-Ground Gun Systems for Close Support Aircraft, RAD 8-218 (1), 5 Jan 1968.
- <sup>28</sup> AFSC Historical Publication: "The Development and Acquisition of the GAU-8/A: The A-10's Tank Buster (U) 1966-1976", Malcolm D. Wall, Office of History, Headquarters, Air Force Systems Command, United States Air Force, 12 Mar 1981.
- <sup>29</sup> AFRDQ (Directorate of Operational Requirements and Development Plans, Deputy Chief of Staff/Research and Development) A-X Proposal, Deputy for Studies and Analyses, Systems Engineering Group, WPAFB, OH, 19 April 1967, pp 52-72.
- <sup>30</sup> *Ibid.*, p 64.
- <sup>31</sup> AFSC Historical Publication: "The A-X Specialized Close Air Support Aircraft: Origins and Concept Phase, 1961-1970", Edward C. Mishler, Office of History, Headquarters, Air Force Systems Command, United States Air Force, 15 Jun 1977, p 35.
- <sup>32</sup> *Ibid.*, p 38.
- <sup>33</sup> Working Paper, History of Tactical Division, Directorate of Operational Requirements and Development Plans, DCS/R&D, HQ USAF, 1 Jul – 31 Dec 67, in files, Ofc of Hist, HQ AFSC.

- 
- <sup>34</sup> A-X Concept Formulation Package, Control # RT-370, Department of the Air Force, 1 March 1968, Revised 13 May 1968, p 1.
- <sup>35</sup> Ibid., pp 4-5.
- <sup>36</sup> Ibid., p I-12.
- <sup>37</sup> Ibid., p I-10.
- <sup>38</sup> Ibid., p I-52.
- <sup>39</sup> Ibid., p I-14.
- <sup>40</sup> Ibid., p I-48.
- <sup>41</sup> Ibid., p I-67.
- <sup>42</sup> Ibid., p I-106.
- <sup>43</sup> Ibid., p II-5.
- <sup>44</sup> Report, "CAS Gun System Study", (AFATL 69-4125), September 1969, pp 14-20.
- <sup>45</sup> Ibid., p III-4.
- <sup>46</sup> AFSC Historical Publication: "The A-X Specialized Close Air Support Aircraft: Origins and Concept Phase, 1961-1970", Edward C. Mishler, Office of History, Headquarters, Air Force Systems Command, United States Air Force, 15 Jun 1977, pp 57-62.
- <sup>47</sup> Dr. Foster's final recommendation, dated 14 Dec 68, associated with Development Concept Paper DCP-23.
- <sup>48</sup> AFSC Historical Publication: "The A-X Specialized Close Air Support Aircraft: Origins and Concept Phase, 1961-1970", Edward C. Mishler, Office of History, Headquarters, Air Force Systems Command, United States Air Force, 15 Jun 1977, p 61.
- <sup>49</sup> Ibid., p 75.
- <sup>50</sup> Ibid., p 78.
- <sup>51</sup> Handwritten note by Deputy Secretary of Defense Packard on DCP-23A, 6 April 1970.
- <sup>52</sup> AFSC Historical Publication: "The A-X Specialized Close Air Support Aircraft: Origins and Concept Phase, 1961-1970", Edward C. Mishler, Office of History, Headquarters, Air Force Systems Command, United States Air Force, 15 Jun 1977, p 83.
- <sup>53</sup> Peter C. Smith, "Fairchild Republic A-10 Thunderbolt II", The Crowood Press, Ramsbury, England, 2000, p 78.
- <sup>54</sup> Ibid., p 92.
- <sup>55</sup> Ibid., p 94.
- <sup>56</sup> Defense Systems Acquisition Review Council Briefing, A-X Specialized Close Air Support Aircraft, 17 December 1970.
- <sup>57</sup> Memorandum for Commander, Aeronautical Systems Division, Air Force Systems Command, from SECAF Seamans, subj: Source Selection Division for the Competitive Prototype Phase of the A-X Program, 22 Dec 70.
- <sup>58</sup> Defense Systems Acquisition Review Council Briefing, A-X Specialized Close Air Support Aircraft, 17 December 1970.
- <sup>59</sup> Report, Close Air Support Gun System Independent Estimate, 26 October 1970. Prepared by the Independent Cost Estimate Team, Armament Development and Test Center, Eglin AFB, FL.
- <sup>60</sup> AFSC Historical Publication: "The A-10 Close Air Support Aircraft: From Development to Production 1970-1976", George M. Watson, Office of History, Headquarters, Air Force Systems Command, United States Air Force, p 9.
- <sup>61</sup> Ibid., p 8.
- <sup>62</sup> Memorandum for the Record, Col Hildebrandt, subj: Air Force SPO/Contractor Relationships During the A-X Competitive Prototype Program, April 1971.
- <sup>63</sup> Article, "Northrop Streamlines A-9A Management", *Aviation Week and Space Technology*, 26 Jun 1972, p 109.
- <sup>64</sup> AFSC Historical Publication: "The A-10 Close Air Support Aircraft: From Development to Production 1970-1976", George M. Watson, Office of History, Headquarters, Air Force Systems Command, United States Air Force, p 17.
- <sup>65</sup> Henderson, Breck W. "A-10 'Warthogs' damaged heavily in Gulf War bug survived to fly again." *Aviation Week and Space Technology*, 5 August 1991.
- <sup>66</sup> AFSC Historical Publication: "The A-10 Close Air Support Aircraft: From Development to Production 1970-1976", George M. Watson, Office of History, Headquarters, Air Force Systems Command, United States Air Force, p 23.
- <sup>67</sup> Ibid., p 25.
- <sup>68</sup> Minutes, DSARC Review of the A-X Aircraft Program – Milestone II, 17 Jan 1973.



- 
- <sup>69</sup> AFSC Historical Publication: “The A-10 Close Air Support Aircraft: From Development to Production 1970-1976”, George M. Watson, Office of History, Headquarters, Air Force Systems Command, United States Air Force, pp 27-29.
- <sup>70</sup> GAU-8/A, DSARC II Briefing, May 1973.
- <sup>71</sup> AFSC Historical Publication: “The A-10 Close Air Support Aircraft: From Development to Production 1970-1976”, George M. Watson, Office of History, Headquarters, Air Force Systems Command, United States Air Force, p 32.
- <sup>72</sup> Ibid., p 39.
- <sup>73</sup> Ltr., Edward G. Uhl, President and CEO, Fairchild Industries, to Gen George S. Brown, Chief of Staff, USAF, 4 February 1974.
- <sup>74</sup> A Comparative Flight Evaluation of the YA-10 and A-7D (SABER COMPARE), Executive Summary, USAF Assistant Chief of Staff, Studies and Analysis, June 1974.
- <sup>75</sup> Ibid., p v.
- <sup>76</sup> Ibid., p v.
- <sup>77</sup> Campbell, Douglas, N. *The Warthog and the Close Air Support Debate*, Naval Institute Press, Annapolis, 2003, p 109.
- <sup>78</sup> Ibid.
- <sup>79</sup> AFSC Historical Publication: “The Development and Acquisition of the GAU-8/A: The A-10’s Tank Buster (U) 1966-1976”, Malcolm D. Wall, Office of History, Headquarters, Air Force Systems Command, United States Air Force, 12 Mar 1981, p 39.
- <sup>80</sup> Ibid., p 43.
- <sup>81</sup> Ibid., p 45.
- <sup>82</sup> Ibid., p 53.
- <sup>83</sup> Campbell, Douglas, N. *The Warthog and the Close Air Support Debate*, Naval Institute Press, Annapolis, 2003, p 128.
- <sup>84</sup> Special Report, Medical and Environmental Evaluation of Depleted Uranium, Vol I, April 1974, prepared by the JTCG/ME ad hoc Working Group for Depleted Uranium.
- <sup>85</sup> AFSC Historical Publication: “The Development and Acquisition of the GAU-8/A: The A-10’s Tank Buster (U) 1966-1976”, Malcolm D. Wall, Office of History, Headquarters, Air Force Systems Command, United States Air Force, 12 Mar 1981, p 55.
- <sup>86</sup> Special Report, Medical and Environmental Evaluation of Depleted Uranium, Vol I, April 1974, prepared by the JTCG/ME ad hoc Working Group for Depleted Uranium.
- <sup>87</sup> Smith, Peter, C., *Fairchild-Republic A-10 Thunderbolt II*, The Crowood Press, Berkshire, UK, 2000, p 48.
- <sup>88</sup> Ibid., p 48.
- <sup>89</sup> Campbell, Douglas, N. *The Warthog and the Close Air Support Debate*, Naval Institute Press, Annapolis, 2003, p 96.
- <sup>90</sup> Smith, Peter, C., *Fairchild-Republic A-10 Thunderbolt II*, The Crowood Press, Berkshire, UK, 2000, p 51.
- <sup>91</sup> Smith, Peter, C., *Fairchild-Republic A-10 Thunderbolt II*, The Crowood Press, Berkshire, UK, 2000, p 50.
- <sup>92</sup> AFSC Historical Publication: “The A-10 Close Air Support Aircraft: From Development to Production 1970-1976”, George M. Watson, Office of History, Headquarters, Air Force Systems Command, United States Air Force, pp 68-69.
- <sup>93</sup> Ibid., pp 71-75.
- <sup>94</sup> Ibid.
- <sup>95</sup> Ibid., p 78.
- <sup>96</sup> Smith, Peter, C., *Fairchild-Republic A-10 Thunderbolt II*, The Crowood Press, Berkshire, UK, 2000, p 52.
- <sup>97</sup> Memorandum for the Secretary of the Air Force from DEPSECDEF Clements, subj: A-10 Production Decision, 31 July 1974.
- <sup>98</sup> AFSC Historical Publication: “The A-10 Close Air Support Aircraft: From Development to Production 1970-1976”, George M. Watson, Office of History, Headquarters, Air Force Systems Command, United States Air Force, p 90.
- <sup>99</sup> Ibid, p 54.
- <sup>100</sup> AFSC Historical Publication: “The Development and Acquisition of the GAU-8/A: The A-10’s Tank Buster (U) 1966-1976”, Malcolm D. Wall, Office of History, Headquarters, Air Force Systems Command, United States Air Force, 12 Mar 1981, p 69.
- <sup>101</sup> Ibid, p 122.

- 
- <sup>102</sup> Campbell, Douglas, N. *The Warthog and the Close Air Support Debate*, Naval Institute Press, Annapolis, 2003, p 136.
- <sup>103</sup> GAO Report, "Close Air Support: Satus of the Air Force's Efforts to Replace the A-10 Aircraft", GAO/NSIAD-88-211, September 1988.
- <sup>104</sup> Campbell, Douglas, N. *The Warthog and the Close Air Support Debate*, Naval Institute Press, Annapolis, 2003, p 165.
- <sup>105</sup> GAO Report, "Operation Desert Storm: Evaluation of the Air Campaign", GAO/NSIAD-97-134, June, 1997.
- <sup>106</sup> Campbell, Douglas, N. *The Warthog and the Close Air Support Debate*, Naval Institute Press, Annapolis, 2003, p 181.
- <sup>107</sup> Ibid., p 179.
- <sup>108</sup> Web site: Pats-World.com, A-10 Thunderbolt II "Warthog" A-10 Battle Damage, <http://www.pats-world.com/gulfwar/home.htm>.
- <sup>109</sup> Ibid.
- <sup>110</sup> Report, *A-10 Red Team Independent Review Final Report*, Air Force Materiel Command, 18 February 2003.
- <sup>111</sup> Northrop Grumman Report, *A/OA-10 Aircraft Structural Integrity Program Report*, Ogden ALC A-10 Prime Contract, 15 August 2007.
- <sup>112</sup> Report, *A-10 Red Team Independent Review Final Report*, Air Force Materiel Command, 18 February 2003, p 59.
- <sup>113</sup> Ibid.
- <sup>114</sup> Ibid., p 7.
- <sup>115</sup> Correspondence with A-10 Program Office engineer, March, 2008.
- <sup>116</sup> Report, *A-10 Red Team Independent Review Final Report*, Air Force Materiel Command, 18 February 2003, p 39.
- <sup>117</sup> Ibid., p 40.
- <sup>118</sup> Ibid., p 62.
- <sup>119</sup> Ibid., p 8.
- <sup>120</sup> Ibid., p 9.
- <sup>121</sup> Ibid., p 9.
- <sup>122</sup> Ibid., p 8.
- <sup>123</sup> Ibid., p 2.
- <sup>124</sup> Ibid., p 10.
- <sup>125</sup> Northrop Grumman Report, *A/OA-10 Aircraft Structural Integrity Program Report*, Ogden ALC A-10 Prime Contract, 15 August 2007.
- <sup>126</sup> Article, *Old "Hogs" Get New Life*, Air Force Print News Today, 8 August 2007.
- <sup>127</sup> Briefing, *A-10 Health Briefing to ACC/LG*, Ogden ALC, 30 August 2005.
- <sup>128</sup> Exhibit R-2, RDT&E Budget Item Justification, PE# 0207131F, PE Title: A-10 Squadrons, February 2006.
- <sup>129</sup> Article: *A-10 Program Completes 100<sup>th</sup> PE Upgrade*, Air Force Print News Today, 14 January 2008.

## Appendix A: Friedman-Sage Matrix with A-10 Learning Principles

	Concept Domain	Responsibility Domain		
		1. Contractor Responsibility	2. Shared Responsibility	3. Government Responsibility
A.	Requirements Definition and Management		<i>LP-1: The system concept and preliminary design must follow, not precede, the mission analysis.</i>	<i>LP1</i>
B.	Systems Architecture and Conceptual Design		<i>LP1</i>	<i>LP6: If the politics don't fly, the system never will.</i>
C.	System and Subsystem Detailed Design and Implementation		<i>LP1</i>	
D.	Systems Integration and Interface			<i>LP-3: Clear lines of responsibility must be established to ensure successful integration, especially when multiple programs are involved.</i>
E.	Validation and Verification			
F.	Deployment and Post Deployment			<i>LP-5: Successful design, development and production is not enough to sustain a system throughout its life cycle.</i>
G.	Life Cycle Support	<i>LP-4: The government must ensure the contractor is able to "Walk the Talk" when it comes to production.</i>		<i>LP5</i>
H.	Risk Assessment and Management			<i>LP-2: Prototyping can be used to help manage technical and cost risk at the system, subsystem, and component level; LP4</i>
I.	System and Program Management		<i>LP4</i>	

For discussion of the Learning Principles, the reader is referred to the Executive Summary for this case study.

## **Appendix B: Author Biographies**

### ***David R. Jacques***

Dr. David Jacques (LtCol, USAF-Ret) is currently a faculty member at the Air Force Institute of Technology (AFIT) where he chairs the graduate Systems Engineering program and was instrumental in the establishment and activation of the Air Force Center for Systems Engineering. During over 24 years of combined military and civil service he has had assignments spanning tactical missile intelligence analysis, ballistic missile test and evaluation, and research and development of advanced munition concepts. He has twice received AF level recognition for his work; in 1998 for Outstanding Contributions to USAF Research and Development, and in 2002 as an Air Force Outstanding Science and Engineering Educator. Dr. Jacques teaches in both the Systems and Aeronautical Engineering programs at AFIT, and specializes in the up front application of Systems Engineering for concept definition, requirements generation and system analysis. His research interests include architecture based evaluation, multi-objective and constrained optimal design, and cooperative behavior and control of autonomous vehicles. Dr. Jacques holds PhD and MS degrees in Aeronautical Engineering from AFIT, and a BS degree in Mechanical Engineering from Lehigh University. Dr. Jacques is a member of INCOSE, and an Associate Fellow of the American Institute of Aeronautics and Astronautics (AIAA).

### ***Dennis D. Strouble***

Dennis D. Strouble, PhD, JD, is on the faculty at the Air Force Institute of Technology at Wright-Patterson Air Force Base. During the “cold war” he was a Regular Army Officer in the Armored Cavalry serving as a platoon leader, staff officer, and troop commander in Europe, Korea and in CONUS. He is a graduate of the Army Command and Staff College, entitled to wear the Ranger Tab and has a real appreciation for the role of CAS in combat. Upon leaving active duty he served with the reserves and was a Lt. Col. upon discharge. Dr. Strouble practiced law as a trial attorney in Texas prior to beginning a teaching career. He has taught at The Pennsylvania State University, Bowling Green State University, and the University of Dallas, Graduate School. He has an undergraduate degree in Management from The Pennsylvania State University, a Masters in Systems Management from the University of California, and a Juris Doctorate, and PhD in Management from Texas Tech University. He is also the co-founder of a company that has been listed on the Inc. 500 twice. Dr. Strouble is a member of INCOSE, the Project Management Institute, and the Academy of Management.

## Appendix C: Tactical Air Control System – circa 1968\*

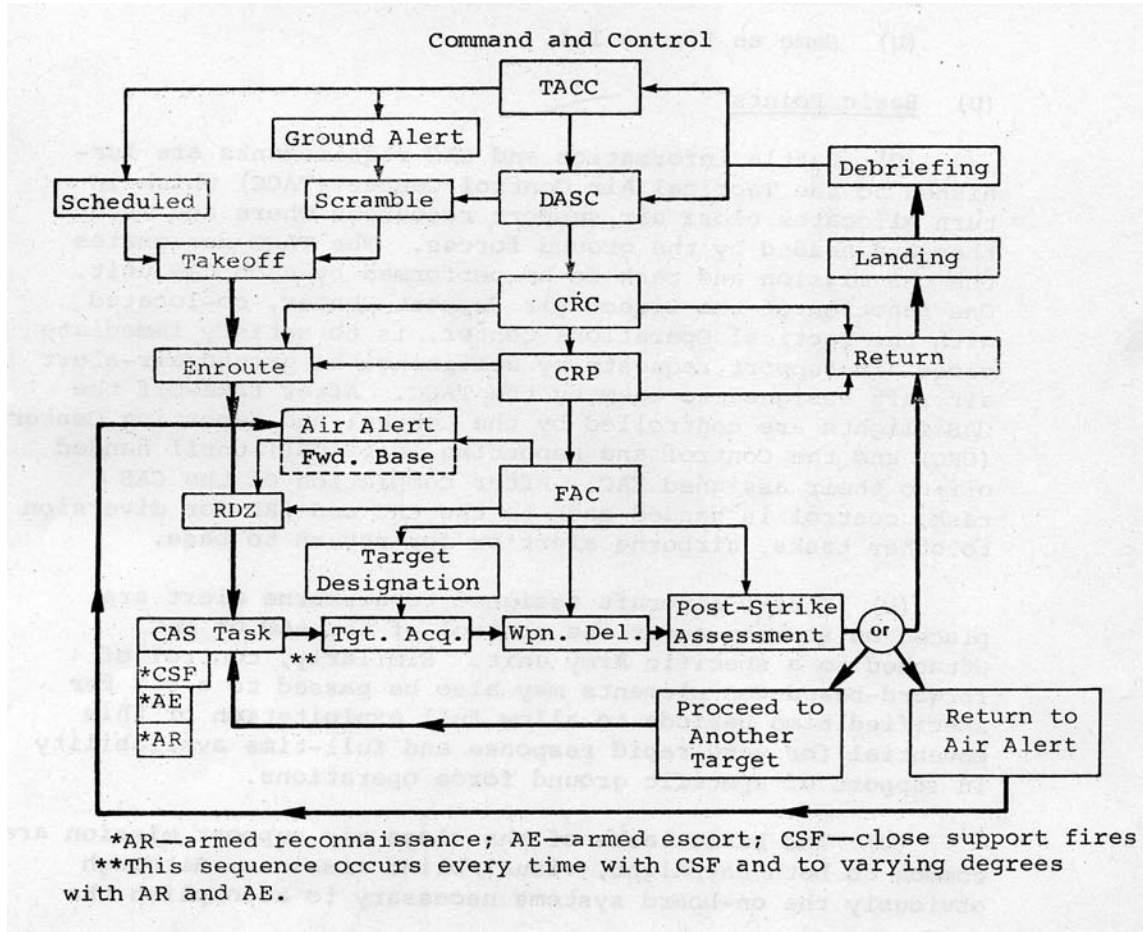

Figure C-1. The Tactical Air Control System (circa 1968)

\* A-X Concept Formulation Package, Control # RT-370, Department of the Air Force, 1 March 1968, Revised 13 May 1968.

(U) TACTICAL AIR CONTROL SYSTEM CAS BREAKOUT

(U) Purpose

(U) To show the interfaces of CAS aircraft with the Tactical Air Control System.

(U) Source of Data

(U) Same as Figure I-1.

(U) Basic Points

(U) Battle information and CAS requirements are furnished to the Tactical Air Control Center (TACC) which in turn allocates close air support resources where and when they are needed by the ground forces. The TACC designates the CAS mission and task to be performed by each CAS unit. One function of the Direct Air Support Center, co-located with the Tactical Operations Center, is to satisfy immediate close air support requests by utilizing the ground/air-alert aircraft assigned to them by the TACC. After take-off the CAS flights are controlled by the Control and Reporting Center (CRC) and the Control and Reporting Post (CRP) until handed off to their assigned FAC. After completion of the CAS task, control is handed back to the CRC and CRP for diversion to other tasks, airborne alert or for return to base.

(U) Strike aircraft assigned to airborne alert are placed on station under the control of the ALO or FAC attached to a specific Army unit. Similarly, control of forward-based CAS elements may also be passed to a FAC for specified time periods to allow full exploitation of this potential for very rapid response and full-time availability in support of specific ground force operations.

(U) The basic tasks of the close air support mission are common to both day/night, visual/blind missions, although obviously the on-board systems necessary to accomplish the

mission vary markedly. The procedures for CAS tasks are discussed below. Where the procedures differ, it is so indicated in parenthetical statements.

a. (U) Communication of attack aircraft with accompanying aircraft, if any.

b. (U) Navigation to and from the target area by self-contained, theater-installed or FAC-provided navigation information.

c. (U) Communication of attack aircraft with escorted force. (AE)

d. (U) Rendezvous with force to be escorted. (AE)

e. (U) Local area search based on identification of local geographical areas (visual or sensor). Familiarity with the minute details of the situation and the enemy's disposition is critical for the success of this phase. (AR)

f. (U) Communication with ground or airborne FAC to receive pre-strike briefing on target description, preferred ordnance and preferred attack tactics. (CSF and AE)

g. (U) Target detection and identification using any combination of visual, aided visual, IR or electromagnetic sensors.

h. (U) Delivery of the proper ordnance within lethal range of the target without endangering friendly troops. This delivery can be based on cooperative tactics with a detecting aircraft marking or illuminating the target for the delivering aircraft, or can be based on the use of sensors on-board the strike aircraft as target location devices for delivery.

i. (U) Post-strike communication with FAC or TACS to assess results and determine further action required (e.g., restrike, proceed to air alert status or to secondary target or to base).

j. (U) Communication of critical target information to relevant surveillance/intelligence units or request for reinforcements from base or from other aircraft in the area. (AR)

k. (U) Recovery to base or diversion.

# Appendix D: Concept Formulation Trade Space Analysis<sup>†</sup>

## Combat Radius and Loiter Time Considerations

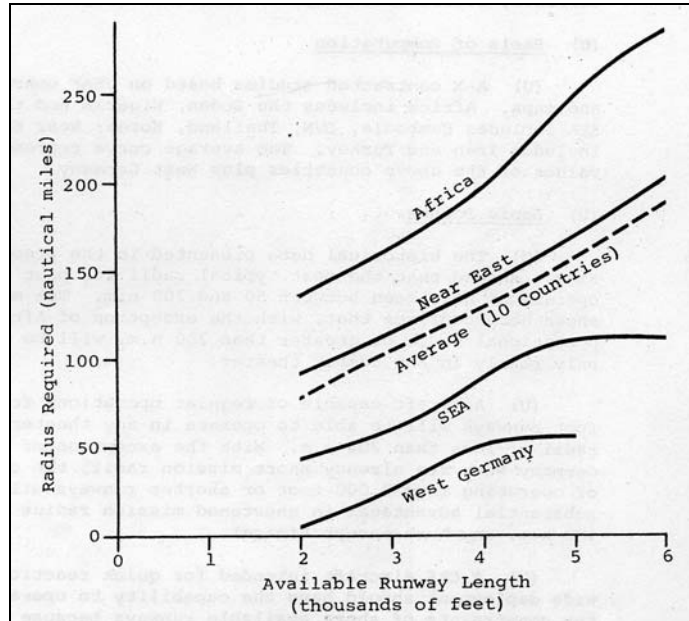

Figure D-1. Radius Req'd for 90-Percent Geo-Area Coverage from Available Runways

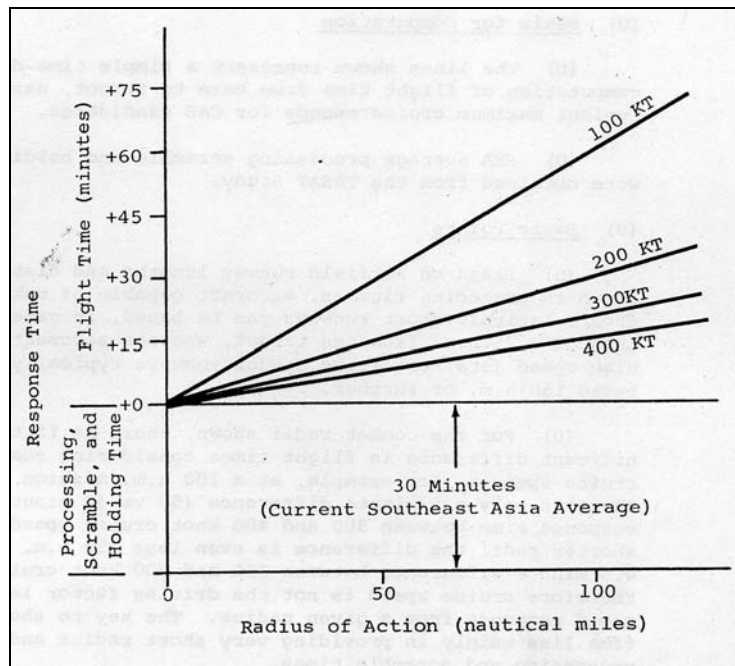

Figure D-2. Response Time Versus Mission Radii and Cruise Speed

<sup>†</sup> A-X Concept Formulation Package, Control # RT-370, Department of the Air Force, 1 March 1968, Revised 13 May 1968.



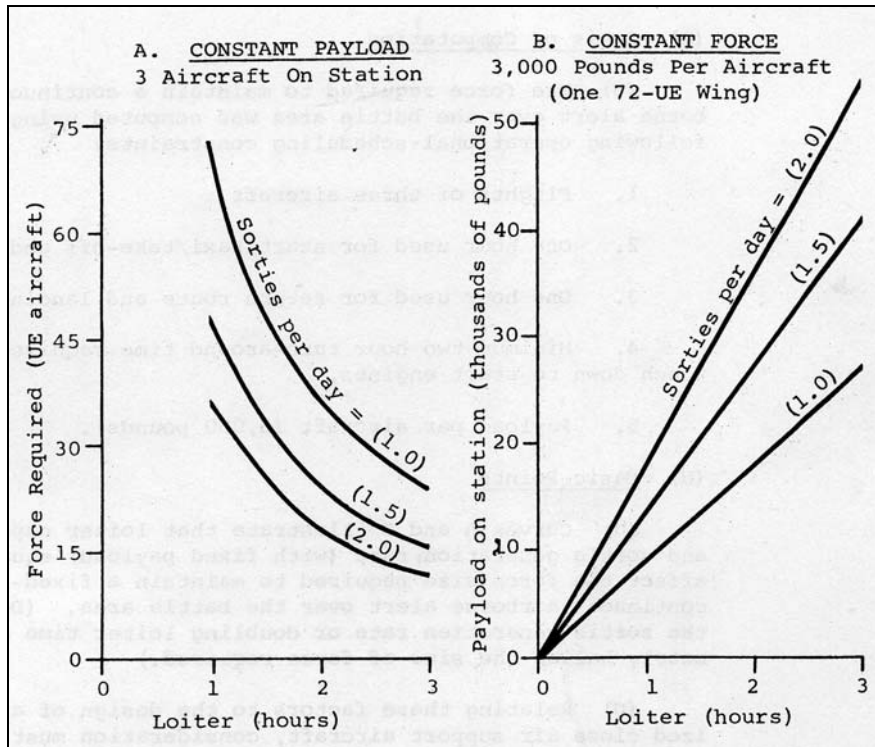

Figure D-3. Impact of Loiter Time and Sortie Rate on Force Requirements

	AFM 26-3 PLANNING MMH/FH	ACTUAL SEA MMH/FH AVERAGE
F-4	30	33.2
*F-105	40	27.6
F-100	25	26.6
F-5	17	15.5
A-1	10	14.3
A-37	7	7.8

\*The large difference between planning factors and actual MMH/FH is in part due to long sortie length in SEA.

Figure D-4. Maintenance Man-Hours per Flying Hour for USAF Fighters

## Survivability

Country	Gun	Guns per 1,000 Men	Number of Barrels/ Shots per Min.	Muzzle Velocity (fps)	Sight Type	Total Weapons
<u>Germany</u> WW II, Motor Division, 13,876 persons	HMG (7.92-mm.)	5.9	1/300-700	2,600	Open	(82)
	20-mm.	4.5	1/120	2,800	Open	63
	20-mm.	.21	4/720	2,800	Open	3
	88-mm.	.58	1/12-15	3,350	Director	8
		5.29				AAA = 74
<u>U.S.S.R.</u> WW II, Infantry Division plus support, 9,619 persons	HMG (7.62-mm.)	14.0	1/250	2,500	Open	( 135)
	12.7-mm.	3.2*	1/80	2,756	Mech/Opt	31
	37-mm.	7.56*	1/80	2,887	Mech/Opt	15
	76.2-mm.	.42	1/unknown	unknown	Unknown	4
	85-mm.	.31*	1/15-20	2,625	Director	3
	5.5				AAA = 53	
<u>E. Germany</u> 1976, Soviet Motor Division, 11,575 persons	HMG (7.62-mm.)	26.8	1/250	2,550	Open	( 310)
	14.5-mm.	45.0**	1/80	3,280	Mech/Opt	522
	23-mm.	1.7	2/120	3,050	Mech/Opt	20
	23-mm.	1.6	4/1,200-1,400	3,050	Radar	18
	57-mm.	1.9	2/160-300	3,280	Mech/Opt	22
	50.5***				AAA = 582	
<u>Korea</u> 1968-72, CCA Infantry Division, 14,915 persons	7.62-mm.	23.0	1/250	2,550	Open	( 342)
	12.7-mm.	3.3	1/80	2,756	Ring	49
	14.5-mm	2.6	1/300	3,280	Mech/Opt	39
	57-mm.	.8	1/70	3,280	Mech/Opt	12
		6.7				AAA = 100
<u>1976</u> NKA Infantry Division plus support, 9,187 persons	HMG (7.62-mm.)	8.8	1/250	2,550	Open	( 81)
	14.5-mm.	2.2	2/300	3,280	Mech/Opt	20
	57-mm.	1.9	1/70	3,280	Mech/Opt	18
	85-mm.	2.6	1/15-20	2,625	Director	24
		6.7				AAA = 140
<u>Vietnam</u> 1975 NVN Infantry Division, 13,687 persons	HMG (7.62-mm.)	4.0	1/250	2,350	Open	( 54)
	12.7-mm.	4.0	1/80	2,756	Ring	54
	14.5-mm.	.89	2/300	3,280	Mech/Opt	12
	57-mm.	.89	1/70	3,280	Radar	12
		5.78				AAA = 78

\*AAA division allocated to Army Corps (20 percent included in totals).

\*\*14.5-mm. probably dual purpose gun.

\*\*\*Surface-to-air missiles not included.

Figure D-5. Anti-Aircraft Weapons (Field Forces)

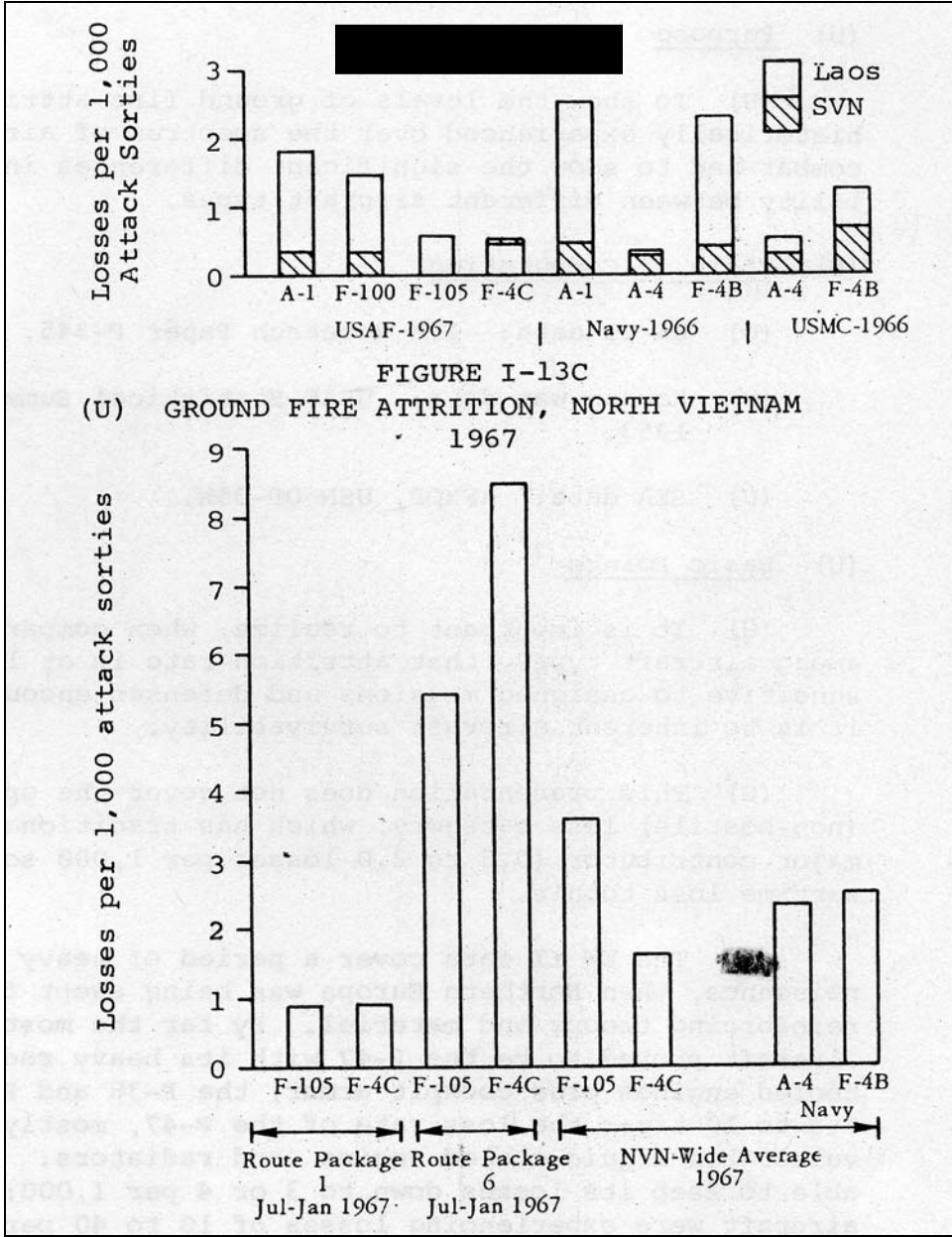

Figure D-6. Ground Fire Attrition in South Vietnam and Laos

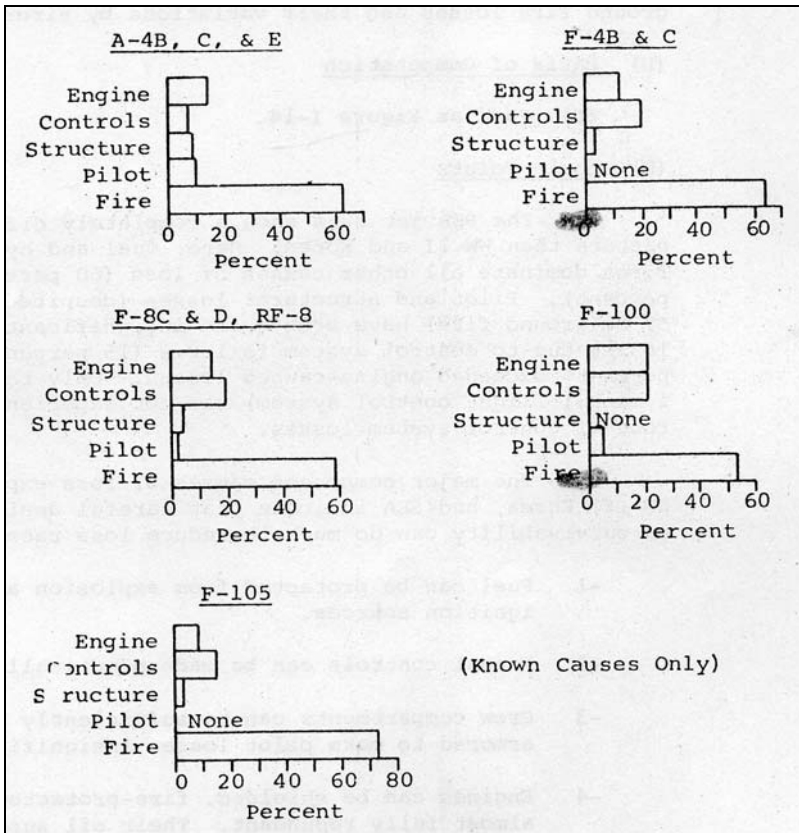

Figure D-7. Cause of Aircraft Ground Fire Loss in Southeast Asia

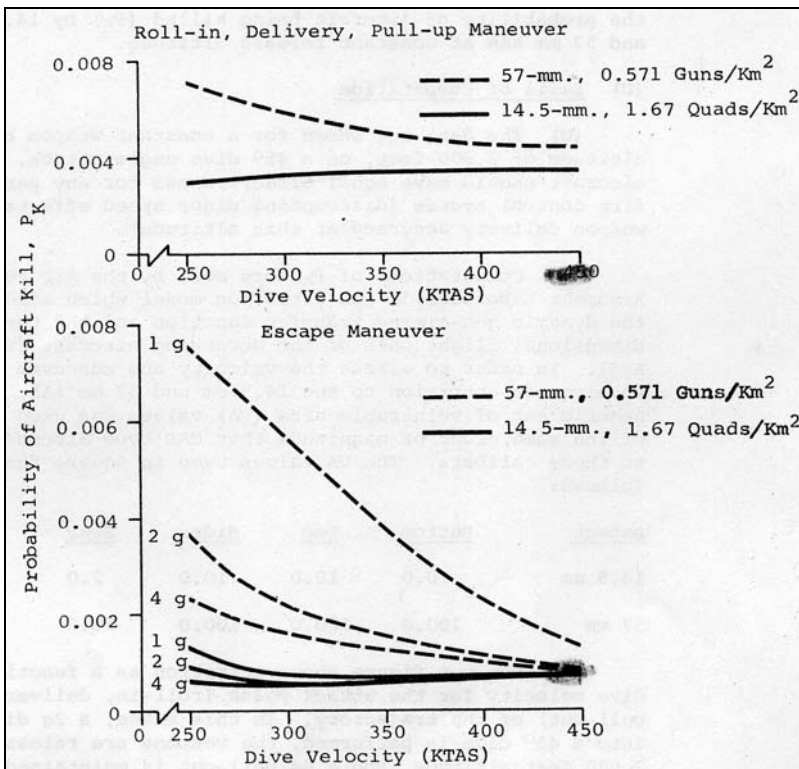

Figure D-8. Relative Aircraft Attrition Versus Velocity and Maneuver

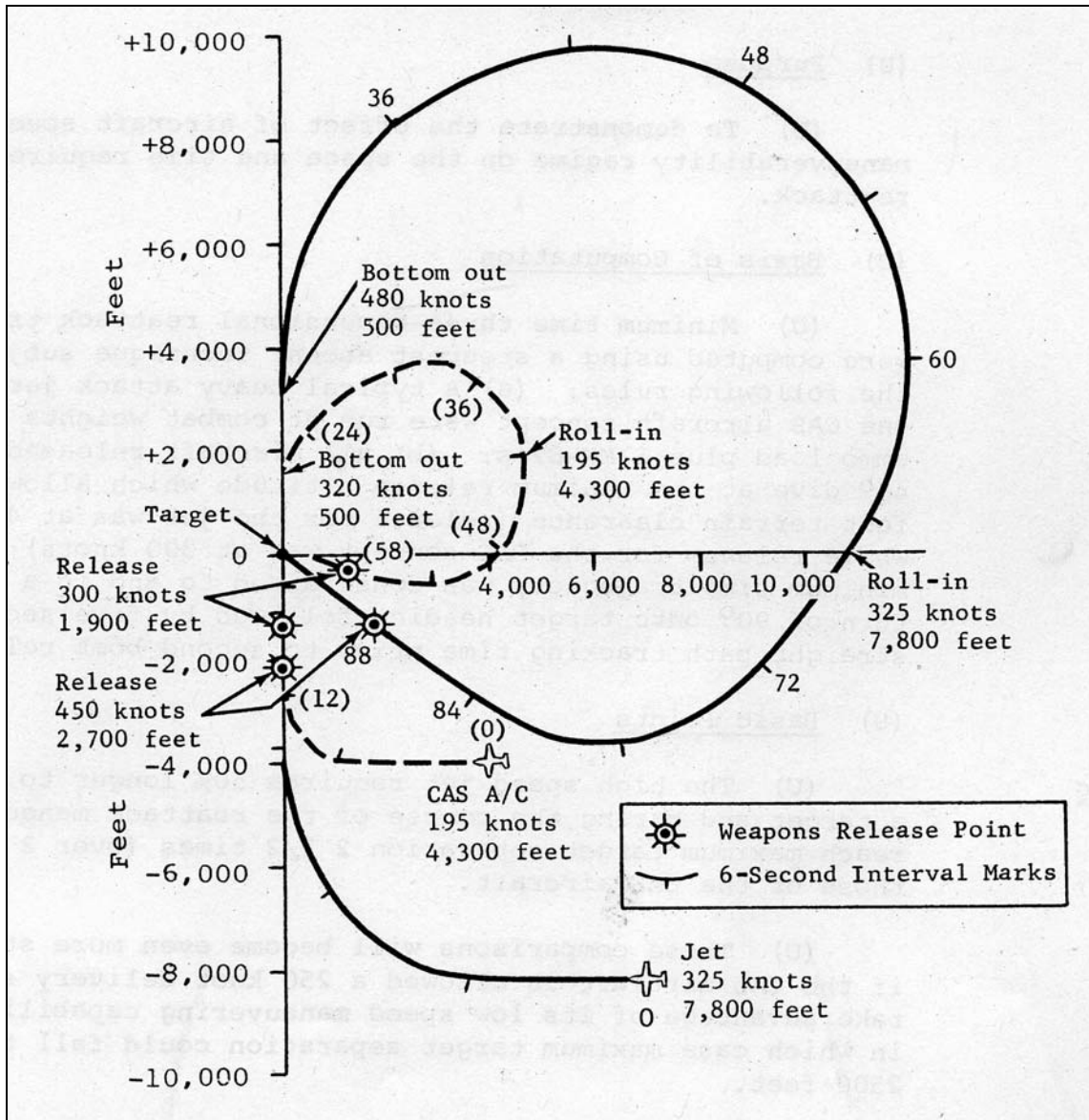

Figure D-9. Time and Space Required for Re-Attack Minimum time Trajectory

# Weather Suitability

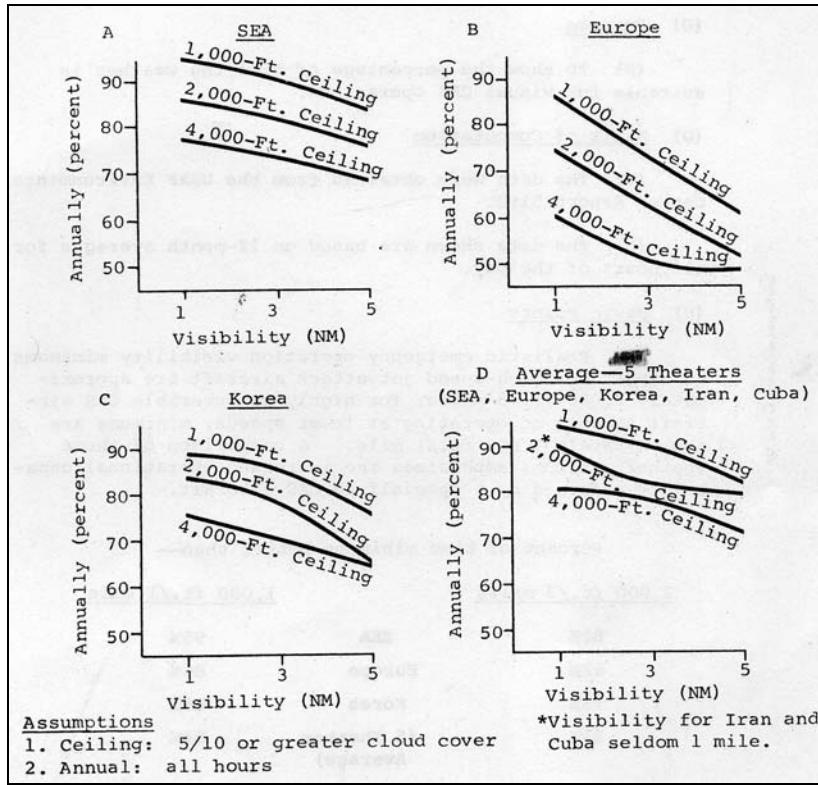

Figure D-10. Availability of Weather Suitable for CAS Operations

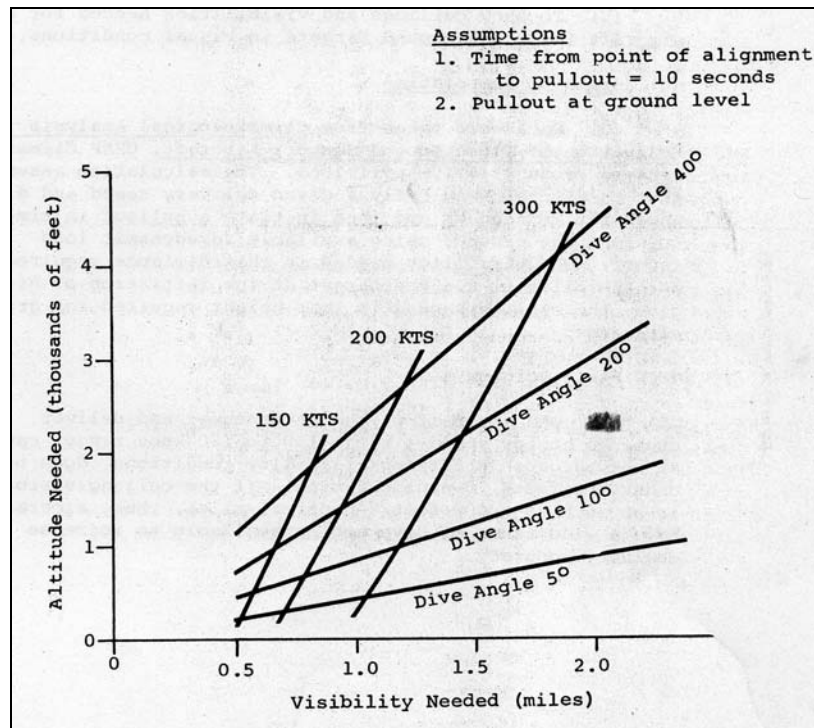
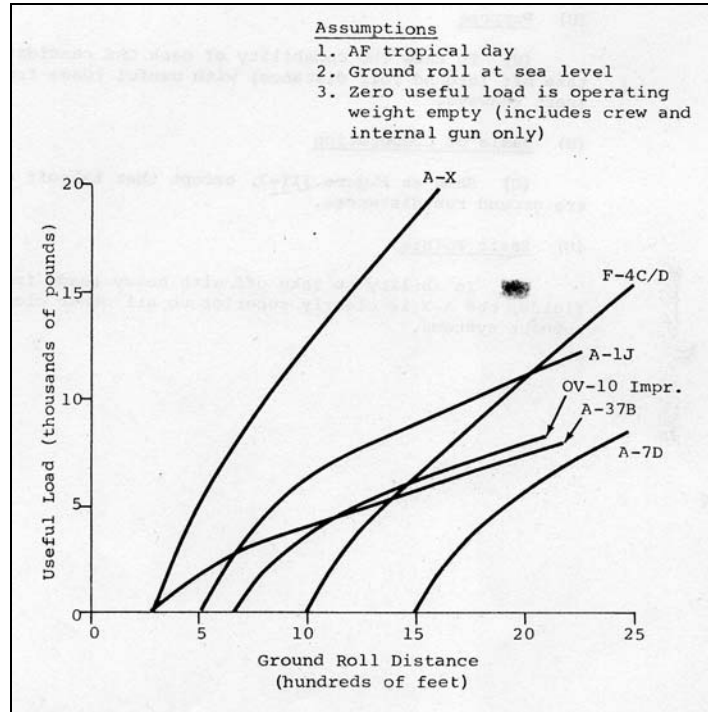
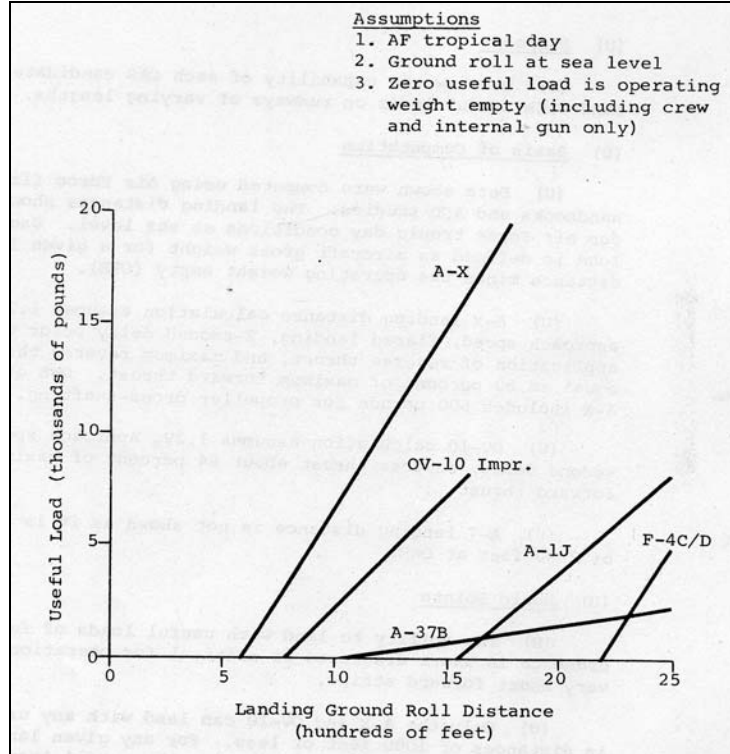

Figure D-11. Attack Profile Nomogram

## Comparison of Candidate Aircraft Characteristics and Cost Effectiveness



**Figure D-12. Useful Load Versus Takeoff Ground Roll Distance**



**Figure D-13. Useful Load Versus Landing Ground Roll Distance**

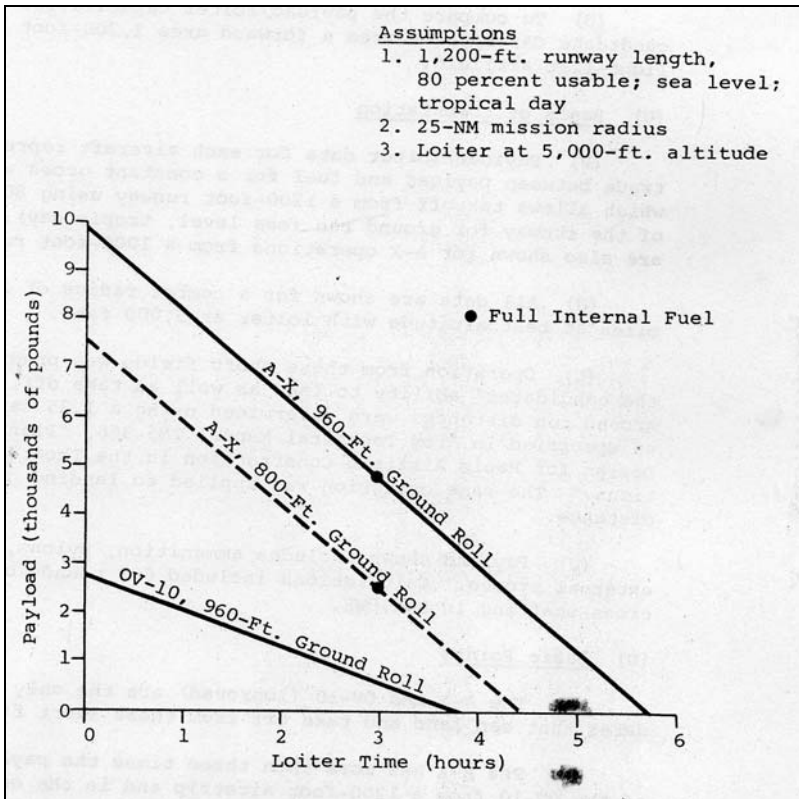

Figure D-14. Payload Versus Loiter Time

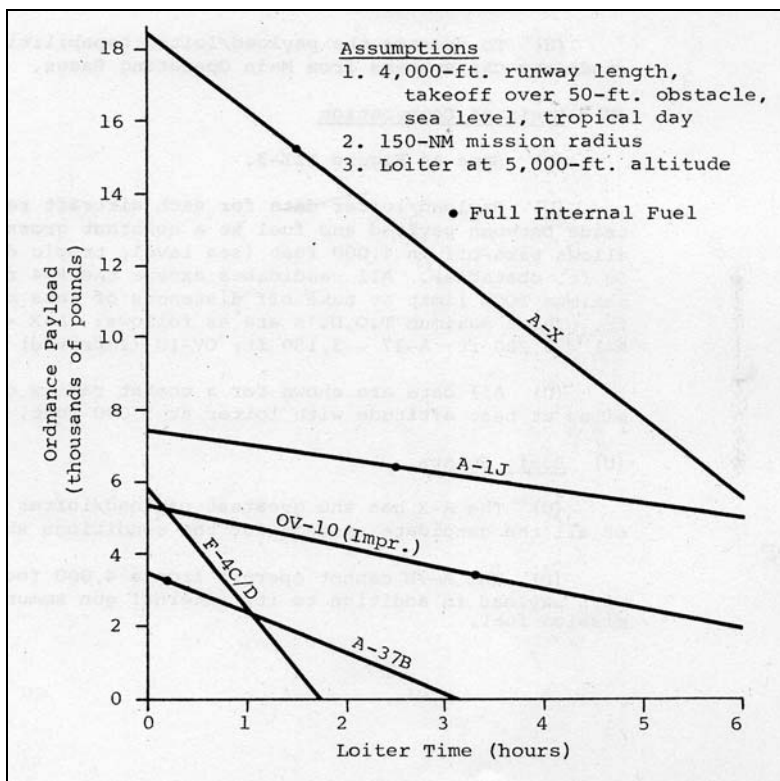

Figure D-15. Ordnance Payload Versus Loiter Time



<u>Ordnance Type</u>	<u>Al-J</u>	<u>A-7D</u>	<u>A-37B</u>	<u>A-X</u>	<u>F-4C/D</u>	<u>OV-10</u> <u>(Impr.)</u>
<u>Free Fall</u>						
250 lbs	15	24	8	28	24	7
500 lbs	13	24	8	28	24	7
800 lbs	3	10	4	20	16	5
1,000 lbs	3	6	n/c	14	11	1
2,000 lbs	3	2	n/c	6	n/c	n/c
3,000 lbs	3	2	n/c	2	n/c	n/c
<u>Dispensers</u>						
500 lbs	13	4	8	20	7	7
800 lbs	3	4	4	16	7	5
1,500 lbs	3	4	n/c	6	n/c	n/c
3,000 lbs	3	n/c	n/c	2	n/c	n/c
<u>Rocket Pods</u>						
100 lbs	14	12	8	12	15	7
500 lbs	12	12	8	12	15	7
<u>Missiles</u>						
BULLPUP A	10	4	n/c	*	4	n/c
BULLPUP B	10	4	n/c	*	4	n/c
MAVERICK	*	4	*	*	*	*
WALLEYE	*	4	*	*	*	*
<u>Store Stations</u>						
Hard Points	15	8	8	10	5	7
Hard Points w/MERS or TERS	none	22	none	28	24	none
Fuel Stations	3	4	4	2	3	3
<u>Max Ordn Load (lb)</u>						
W/full internal fuel incl. racks and pylons	9,392	14,000	4,826	16,260	14,085	4,394
<u>Flare Dispensers</u>	12	*	6	.. ..*	7	

n/c - not capable

\*Not determined - pylon will carry.

Figure D-16. Candidate Comparison Ordnance Capacity

## Appendix E: Concept Formulation – Candidate Configurations<sup>‡</sup>

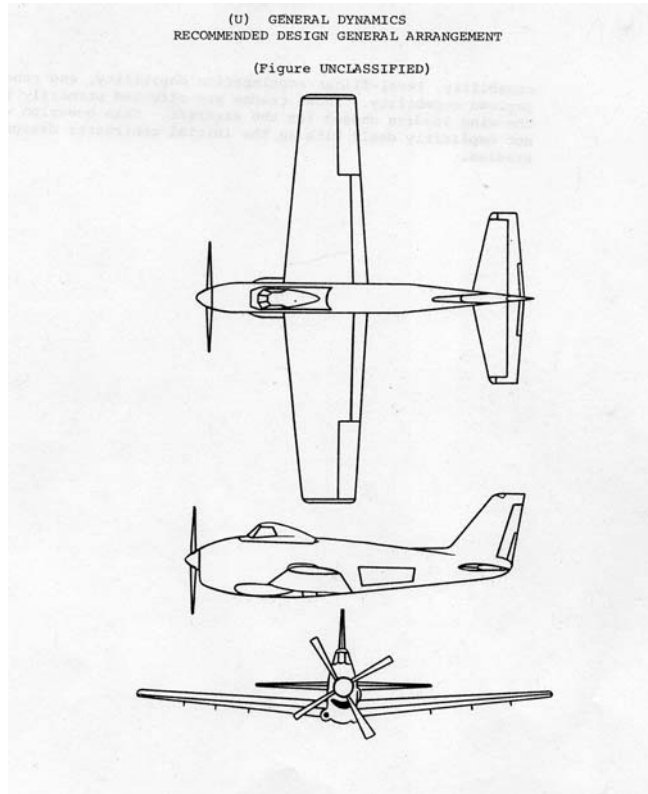

(U) GENERAL DYNAMICS/CONVAIR  
RECOMMENDED DESIGN - GENERAL ARRANGEMENT

The Convair recommended configuration is a single-engine T-64 powered tractor. This configuration represents a simple, low-cost approach to an A-1 improvement. The engine and vertical fin are offset to counteract power effects. A high aspect ratio (AR=6), low taper ratio wing with double-slotted trailing edge flaps is mounted low for ease of ordnance loading and slightly aft of the cockpit.

An internal 30 mm Gatling gun is mounted in the nose, synchronized to fire through the propeller with a 1000 round protected ammunition drum under the cockpit. Six wing stations out-board of the propeller disc, utilizing MER's and TER's, are provided.

Extensive engine armor is employed which provides substantial masking for the pilot in addition to the complete cockpit armor. Fuel is located in protected fuselage and wing tanks. Wing structure is multi-spar for structural survivability. Controls are manual and redundant. Conventional fuselage speed brakes are provided for control of dive speed.

<sup>‡</sup> A-X Concept Formulation Package, Control # RT-370, Department of the Air Force, 1 March 1968, Revised 13 May 1968.

(U) NORTHROP  
RECOMMENDED-DESIGN GENERAL ARRANGEMENT

(Figure UNCLASSIFIED)

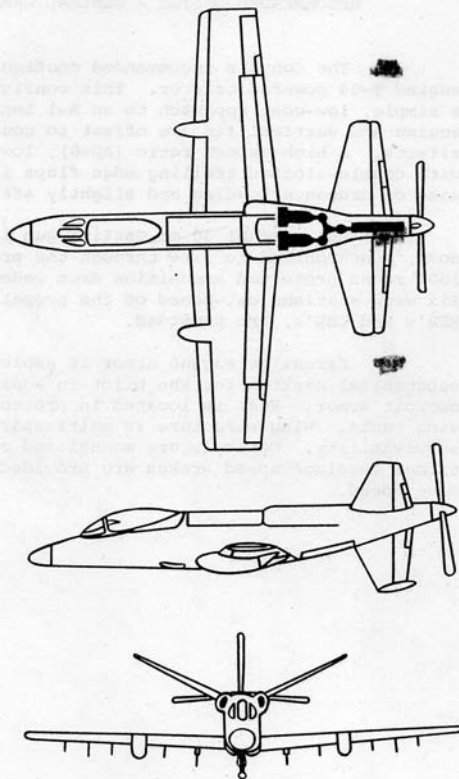

(U) NORTHROP  
RECOMMENDED DESIGN - GENERAL ARRANGEMENT

The Northrop recommended design uses a single or geared-twin T-55 turboprop\* mounted in the fuselage aft of the wing driving, via a short shaft, a single propeller mounted behind the V-shaped empennage. This configuration was chosen to give an unobstructed nose and to eliminate the "torque" (rotating propeller slipstream) and power plus one engine-out effects of conventional tractor arrangements. A penalty in low-speed performance is paid due to the lower lift of the unwashed wing but a drag decrease at higher speeds is obtained. The ventrally-mounted fin is stressed for tail hook loads and gives favorable roll during turns, allowing rudder-only tracking. A high aspect ratio (AR=6), low taper ratio wing with leading and trailing edge flaps is mounted low and well aft of the cockpit for ease of ordnance loading and good visibility.

An internal six barrel 30 mm Gatling gun is mounted on a removable gun pallet just forward of the wing with a 3000 round protected ammunition drum located on the C.G. over the wing. Ten tandem stores stations are provided across the wing out-board of the propeller disc.

Cockpit armor plus engine masking and armor are provided. All fuel is located away from the propulsion system in protected wing tanks. Wing structure is multi-spar for structural survivability. Controls are manual and redundant with aileron boost added for quick roll response. Dive speed is controlled by high drag prop settings and/or split aileron speed brakes.

\*The twin uses one engine only for efficient cruise/loiter.

(U) GRUMMAN  
RECOMMENDED DESIGN GENERAL ARRANGEMENT

(Figure UNCLASSIFIED)

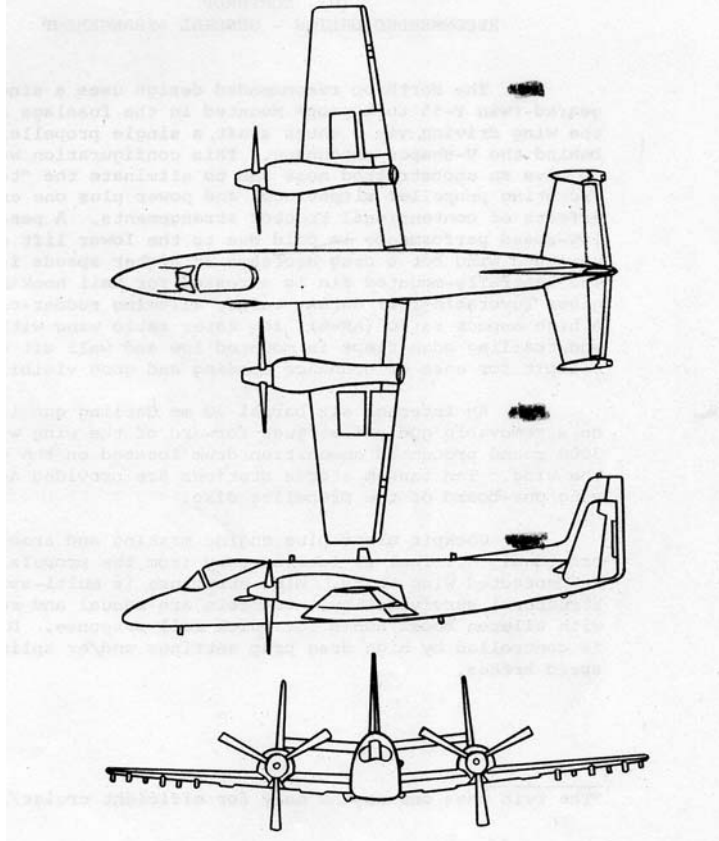

(U) GRUMMAN  
RECOMMENDED DESIGN - GENERAL ARRANGEMENT

The Grumman recommended design uses a twin T-55 tractor arrangement with three vertical fins in order to have one fin always in the propeller slipstream to minimize one engine-out control problems. The configuration was chosen to give an unobstructed nose and to take advantage of propeller wash to increase low-speed lift and performance at some cost in high speed drag. A high aspect ratio (AR=6.6), low taper ratio wing with a single trailing edge flap was chosen to give efficient lift and good roll control even at high g's. The wing is mounted low for ease of ordnance loading and as far aft of the cockpit as possible for good visibility.

Two internal three barrel 30 mm Gatling guns are mounted under the cockpit with two 250 round protected ammunition drums just aft of the cockpit. Twelve wing stores stations out-board of the props and two fuselage stations are provided.

Cockpit armor is provided. Fuel is located in protected fuselage and in-board wing tanks. Multi-spar wing construction for structural survivability is used. Controls are hydraulic and redundant to provide light stick forces and quick response. Conventional fuselage speed brakes are provided for dive control.

(U) McDONNELL DOUGLAS  
RECOMMENDED DESIGN GENERAL ARRANGEMENT

(Figure UNCLASSIFIED)

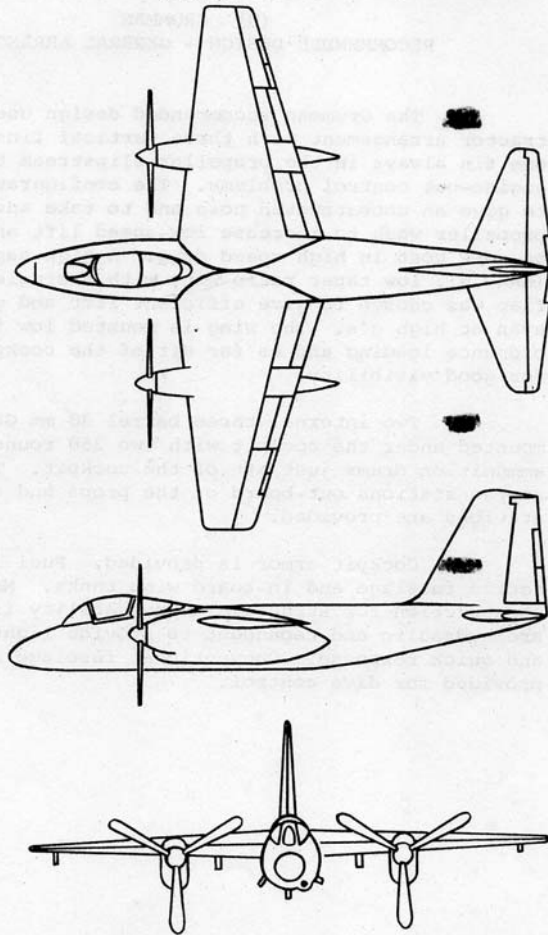

(U) McDONNELL-DOUGLAS  
RECOMMENDED DESIGN - GENERAL ARRANGEMENT

The McDonnell recommended design is a twin T-55 tractor with a large single vertical fin for engine-out control. Propellers rotate in opposite directions to reduce trim changes with power. The configuration was chosen to give an unobstructed nose and to place the largest possible wing area in the propeller slipstream for good low-speed performance (with some attendant drag penalties at higher speeds). A moderate aspect ratio (AR=5), highly tapered wing with trailing edge flaps is mounted high just aft of the cockpit (The high taper and low aspect ratio place more wing area in the propwash).

A single six barrel 30 mm Gatling gun mounted on a pallet with a 500 round protected ammunition drum is located under the cockpit. Four wing stores stations and three fuselage stations utilizing MER's and TER's are provided.

The cockpit is fully armored. Fuel is located in protected fuselage tanks away from the engines. Wing construction is multi-spar for structural survivability. Controls are manual and redundant except for powered spoilers. No speed brakes are provided.

# Appendix F: Proposed A-X Configurations<sup>8</sup>

~~FOR OFFICIAL USE ONLY~~

**A-X**

**DSARC BRIEFING ASD/SDX-9**

**PROPOSED CONFIGURATION**

**FAIRCHILD HILLER (REPUBLIC)**

ENGINE/THRUST TF-34/F3F1/9275#1

~~FOR OFFICIAL USE ONLY~~

<sup>8</sup> Defense Systems Acquisition Review Council Briefing, A-X Specialized Close Air Support Aircraft, 17 December 1970.

FOR OFFICIAL USE ONLY



DSARC BRIEFING ASD/SDX-10

# PROPOSED CONFIGURATION

## BOEING VERTOL

ENGINE/SHP T64/54D-IX/4375 SHP

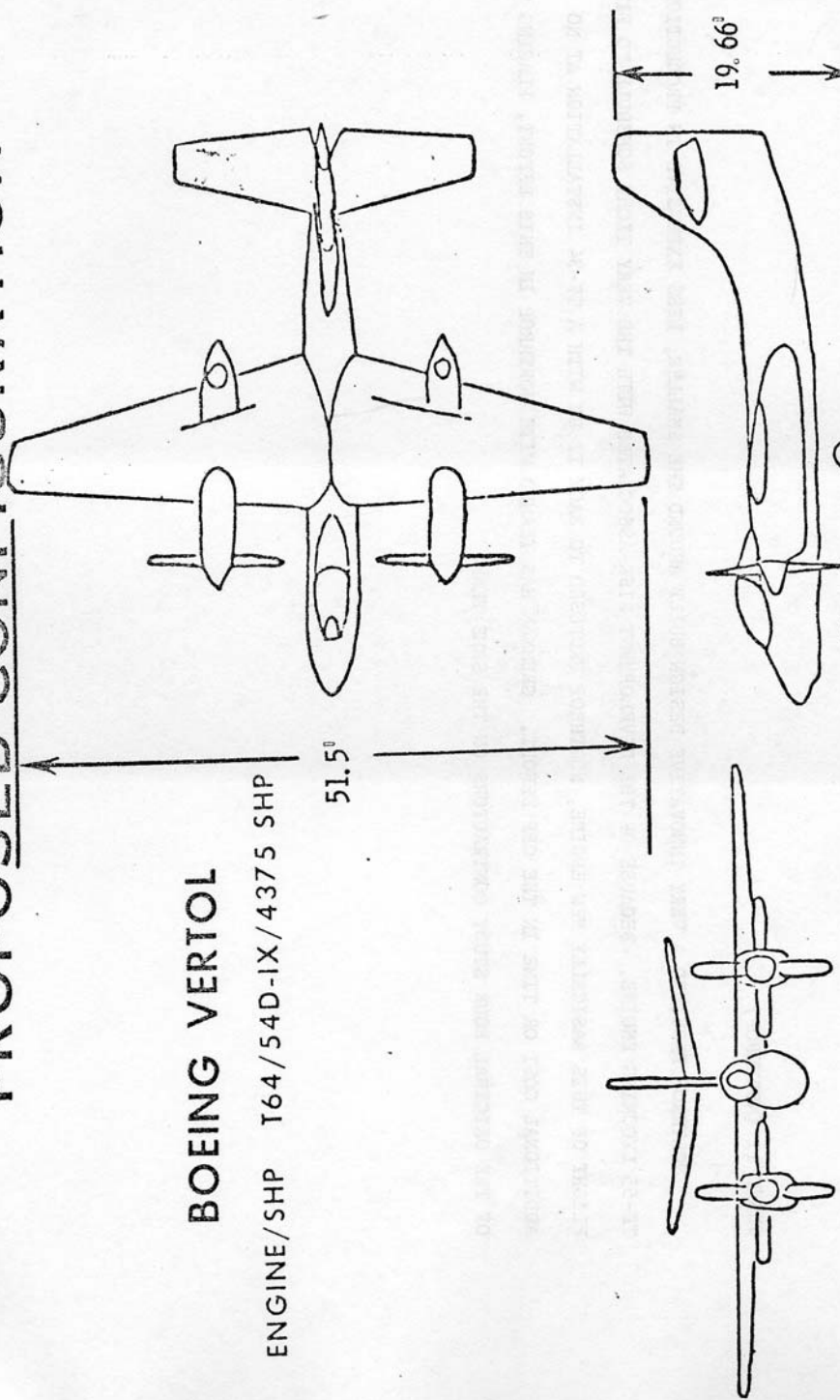

FOR OFFICIAL USE ONLY

~~FOR OFFICIAL USE ONLY~~



~~DSARC BRIEFING ASD/SDX - ( )~~

## PROPOSED CONFIGURATION

NORTHROP

ENGINE/THRUST T-55(FAN)/7200#T

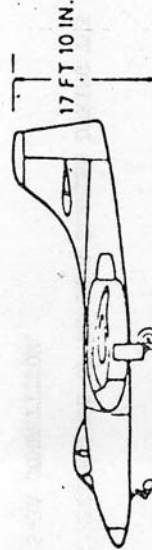
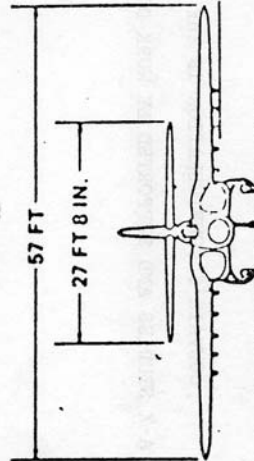
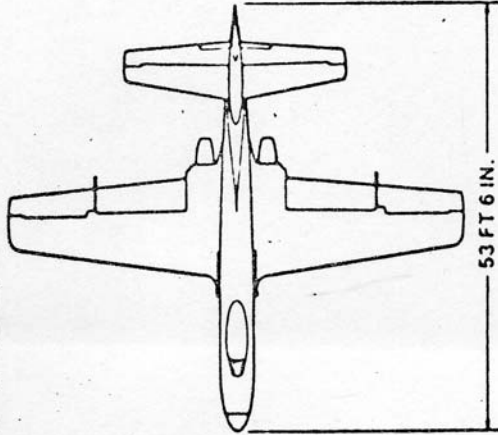

~~FOR OFFICIAL USE ONLY~~



~~FOR OFFICIAL USE ONLY~~

**CAX**

**DSARC BRIEFING**

**ASD/SDX-12**

# PROPOSED CONFIGURATION

**GENERAL DYNAMICS (CONVAIR)**

ENGINE/THRUST TF-34/F3C1 / 9090#1

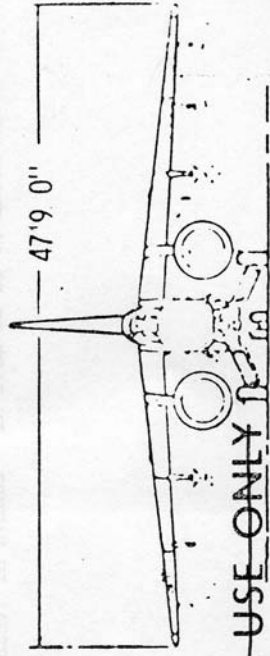
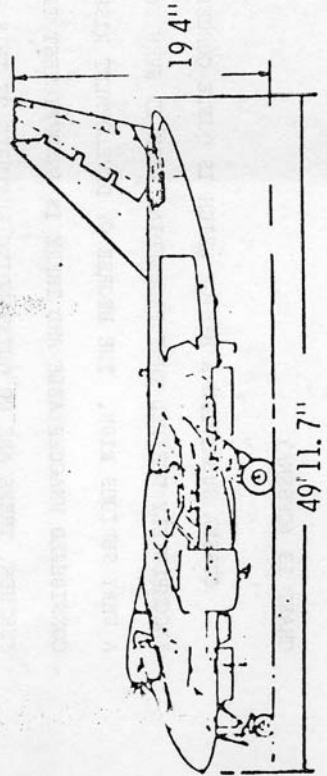
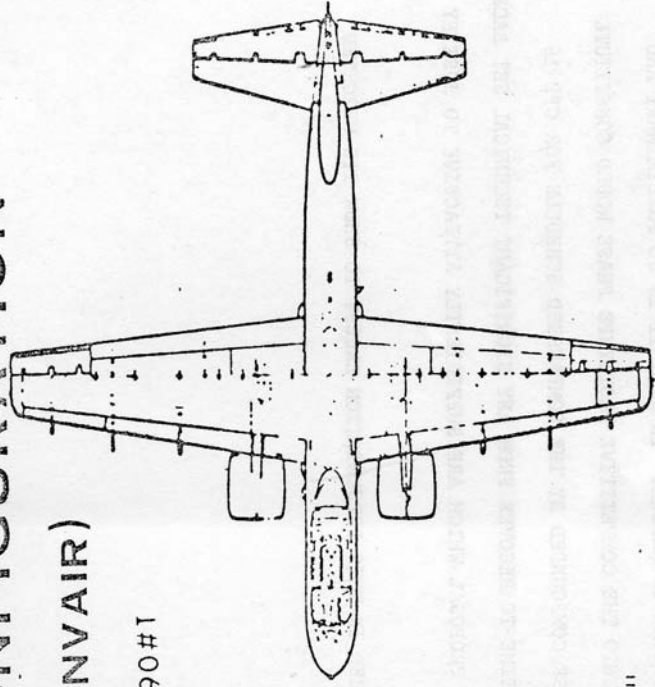

~~FOR OFFICIAL USE ONLY~~

FOR OFFICIAL USE ONLY

AX

DSARC BRIEFING

ASD/SDX-13

# PROPOSED CONFIGURATION

CESSNA

ENGINE/THRUST 1F-34-GE-2/9275#1

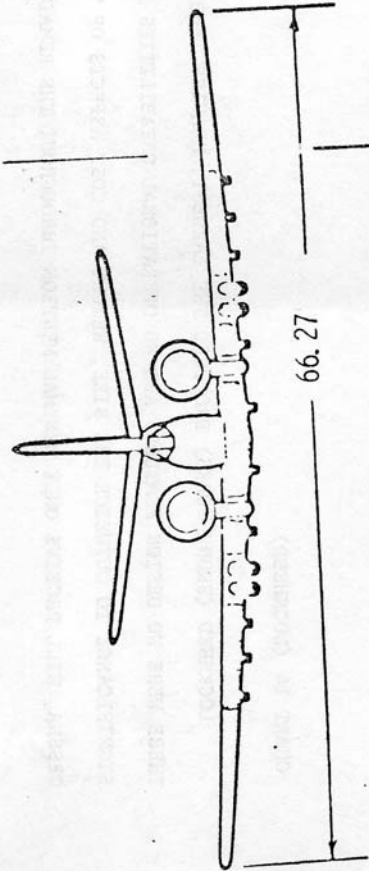
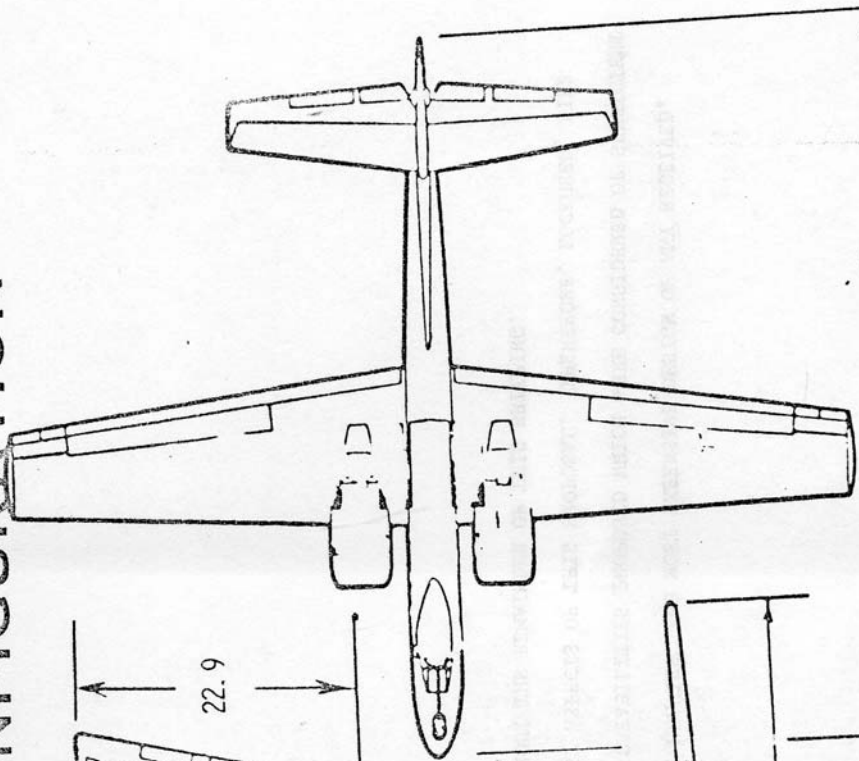

55.58

FOR OFFICIAL USE ONLY

FOR OFFICIAL USE ONLY



DSARC BRIEFING ASD/SDX-14

PROPOSED CONFIGURATION

LOCKHEED

ENGINE/THRUST TF-34-GE-2/9275#T

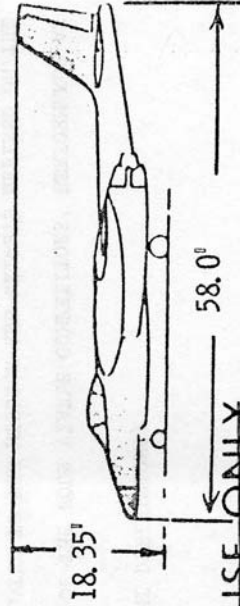
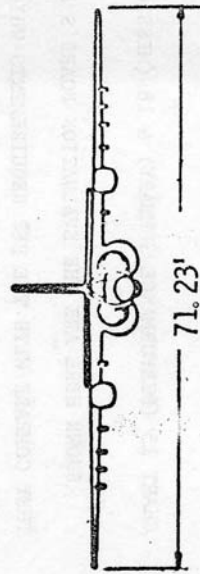
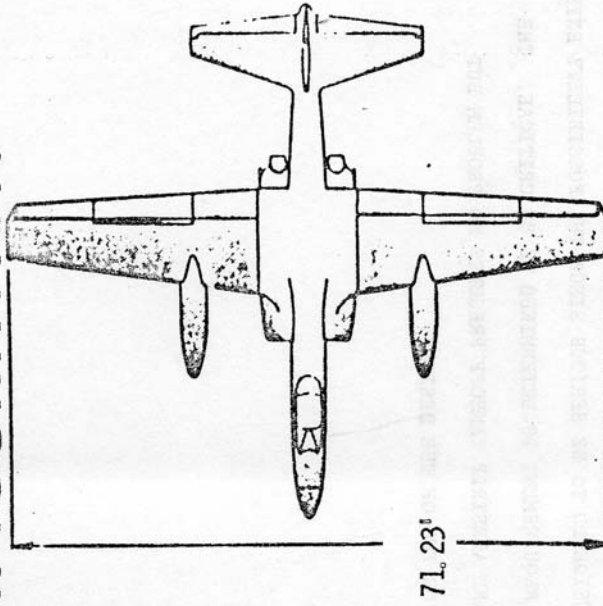
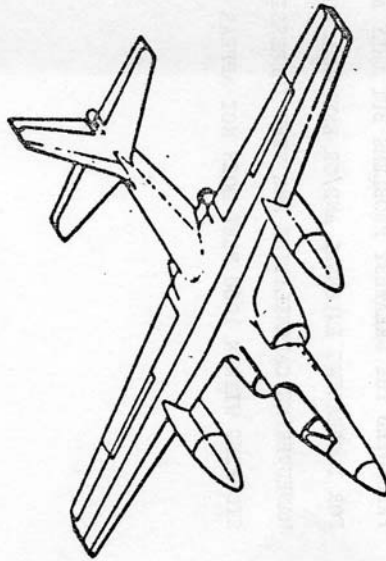

FOR OFFICIAL USE ONLY

CONFIDENTIAL



# DSARC BRIEFING ASD/SDX-15

## PERFORMANCE SUMMARY

ITEM & CONDITION	RFP REQ	FAIRCHILD HILLER	BOEING	NORTHROP	CONVAIR
LOITER TIME - CAS3	2.0 HR	2.23 HR	1.83 HR	1.81 HR	1.63 HR
FERRY RANGE W/50 KT HW	2300 NM	2238 NM	2340 NM	2114 NM	1982 NM
SUST G - BMFDW @ 150 KTAS	2.2	2.30	2.45	2.20	2.35
SUST G - BMFDW @ 275 KTAS	3.5	3.72	3.57	3.74	4.06
INST G - BMFDW @ 150 KTAS	2.2	3.03	2.11	2.30	2.78
INST G - BMFDW @ 300 KTAS	5.0	8.35	5.51	5.45	5.78
TURN RADIUS @ BMFDW	1400 FT	1060 FT	990 FT	1110 FT	1010 FT
TURN RADIUS @ HOW	2000 FT	1490 FT	1500 FT	1440 FT	1410 FT
R/C - BMFDW @ 275 KT @ 5000 FT	5000 FPM	5530 FPM	6950 FPM	4800 FPM	7880 FPM
VMAX - BMFDW @ 5000 FT	350 KTAS	408 KTAS	404 KTAS	394 KTAS	462 KTAS
VMAX - BMFDW @ SEA LEVEL	400 KTAS	420 KTAS	401 KTAS	400 KTAS	440 KTAS
FASW TAKE-OFF DISTANCE	1000 FT	740 FT	620 FT	980 FT	850 FT
FASW LANDING DISTANCE	1000 FT	1110 FT	990 FT	930 FT	1050 FT

CONFIDENTIAL

## Appendix G: Air Force Fact Sheet



# FACT SHEET

### U.S. Air Force Fact Sheet

## A-10/OA-10 THUNDERBOLT II

### Mission

A-10/OA-10 Thunderbolt IIs have excellent maneuverability at low air speeds and altitude, and are highly accurate weapons-delivery platforms. They can loiter near battle areas for extended periods of time and operate under 1,000-foot ceilings (303.3 meters) with 1.5-mile (2.4 kilometers) visibility. Their wide combat radius and short takeoff and landing capability permit operations in and out of locations near front lines. Using night vision goggles, A-10/OA-10 pilots can conduct their missions during darkness.



Thunderbolt IIs have Night Vision Imaging Systems, or NVIS, goggle compatible single-seat cockpits forward of their wings and a large bubble canopy which provides pilots all-around vision. The pilots are protected by titanium armor that also protects parts of the flight-control system. The redundant primary structural sections allow the aircraft to enjoy better survivability during close air support than did previous aircraft.

The aircraft can survive direct hits from armor-piercing and high explosive projectiles up to 23mm. Their self-sealing fuel cells are protected by internal and external foam. Manual systems back up their redundant hydraulic flight-control systems. This permits pilots to fly and land when hydraulic power is lost.

The Thunderbolt II can be serviced and operated from bases with limited facilities near battle areas. Many of the aircraft's parts are interchangeable left and right, including the engines, main landing gear and vertical stabilizers.

Avionics equipment includes multi-band communications; Global Positioning System and inertial navigations systems; infrared and electronic countermeasures against air-to-air and air-to-surface threats. And, it has a Pave Penny laser spot tracker system; a heads-up display to display flight and weapons delivery information; and a low altitude safety and targeting enhancement system, which provides constantly computed impact and release points for accurate ordnance delivery. There is also a low-altitude autopilot and a ground collision avoidance system.

The A-10 is currently undergoing the precision engagement modification, which adds upgraded

cockpit displays, moving map, hands on throttle and stick, digital stores management, LITENING and Sniper advanced targeting pod integration, situational awareness data link or SADL, GPS-guided weapons, and upgraded DC power. Precision engagement modified aircraft are designated as the A-10C.

The Thunderbolt II can employ a wide variety of conventional munitions, including general purpose bombs, cluster bomb units, laser guided bombs, joint direct attack munitions or JDAM), wind corrected munitions dispenser or WCMD, AGM-65 Maverick and AIM-9 Sidewinder missiles, rockets, illumination flares, and the GAU-8/A 30mm cannon, capable of firing 3,900 rounds per minute to defeat a wide variety of targets including tanks.

### **Background**

The first production A-10A was delivered to Davis-Monthan Air Force Base, Ariz., in October 1975. It was designed specially for the close air support mission and had the ability to combine large military loads, long loiter and wide combat radius, which proved to be vital assets to the United States and its allies during Operation Desert Storm and Operation Noble Anvil.

The upgraded A-10C reached initial operation capability in September 2007. Specifically designed for close air support, its combination of large and varied ordnance load, long loiter time, accurate weapons delivery, austere field capability, and survivability has proven invaluable to the United States and its allies. The aircraft has participated in operations Desert Storm, Southern Watch, Provide Comfort, Desert Fox, Noble Anvil, Deny Flight, Deliberate Guard, Allied Force, Enduring Freedom and Iraqi Freedom..

### **General Characteristics**

**Primary Function:** A-10 -- close air support, OA-10 - airborne forward air control

**Contractor:** Fairchild Republic Co.

**Power Plant:** Two General Electric TF34-GE-100 turbofans

**Thrust:** 9,065 pounds each engine

**Wingspan:** 57 feet, 6 inches (17.42 meters)

**Length:** 53 feet, 4 inches (16.16 meters)

**Height:** 14 feet, 8 inches (4.42 meters)

**Weight:** 29,000 pounds (13,154 kilograms)

**Maximum Takeoff Weight:** 51,000 pounds (22,950 kilograms)

**Fuel Capacity:** 11,000 pounds (7,257 kilograms)

**Payload:** 16,000 pounds (7,257 kilograms)

**Speed:** 420 miles per hour (Mach 0.56)

**Range:** 800 miles (695 nautical miles)

**Ceiling:** 45,000 feet (13,636 meters)

**Armament:** One 30 mm GAU-8/A seven-barrel Gatling gun; up to 16,000 pounds (7,200 kilograms) of mixed ordnance on eight under-wing and three under-fuselage pylon stations, including 500 pound (225 kilograms) Mk-82 and 2,000 pounds (900 kilograms) Mk-84 series low/high drag bombs, incendiary cluster bombs, combined effects munitions, mine dispensing munitions, AGM-65 Maverick missiles and laser-guided/electro-optically guided bombs; infrared countermeasure flares; electronic countermeasure chaff; jammer pods; 2.75-inch (6.99 centimeters) rockets; illumination flares and AIM-9 Sidewinder missiles.

**Crew:** One

**Unit Cost:** Not available

**Initial operating capability:** A-10A, 1977; A-10C, 2007

**Inventory:** Active force, A-10, 143 and OA-10, 70; Reserve, A-10, 46 and OA-10, 6; ANG, A-10, 84 and OA-10, 18

### **Point of Contact**

[Air Combat Command](#), Public Affairs Office; 130 Andrews St., Suite 202; Langley AFB, VA

23665-1987; DSN 574-5007 or 757-764-5007; e-mail: [accpa.operations@langley.af.mil](mailto:accpa.operations@langley.af.mil)

October 2007